

The following page(s) are extracted from multi-page Kuhnke product catalogues or CDRoms and any page number shown is relevant to the original document. The PDF sheets here may have been combined to provide technical information about the specific product(s) you have selected.

Hard copy product catalogues, and CDRoms have been published describing Kuhnke Pneumatics, Solenoids, Relays and Electronics; some divided into different books. A list of current publications is available on this web site or from our sales offices. Some may be available for download, but as substantially larger files.

Contact Details

Kuhnke sales and service in North America

Kuhnke
Automation Inc.
P.O Box 1369
Wayne, N.J.

T: (973) 633 0690
F: (973) 633 7230
Email: sales@kuhnkeusa.com

Important Note

The information shown in these documents is for guidance only. No liability is accepted for any errors or omissions. The designer or user is solely responsible for the safe and proper application of the parts, assemblies or equipment described.

Miniature Valves

Manual, Mechanical, Pneumatic and Electrical Valves

Contents:

Product Line Overviews	2	Manually, Mechanically and Pneumatically operated Miniature Valves	39
Micro Solenoid Valves	5	Mechanically Operated Micro	40
10mm Low Power 2/3 Way	6	Modular Poppet Valves 3 Way	42
10mm Standard 2/3 Way	8	Brass 3 Way Valves	44
10mm Manifolds, Accessories	10	Steel Spool Valves 3 / 4 Way	46
10mm Valve Options Chart	15	Pneumatically Operated Valves	50
15mm 3 Way	16	Accessories	53
Miniature Solenoid Valves	19	Appendix	55
16mm Brass 2/3 Way	20	General Information	56
22mm Brass 2/3 Way	22	Index by Catalog Number	59
30mm Brass 2/3 Way	24	Index	60
Spool Valves (10-32 Ports)	26		
Spool Valves (1/8 Ports)	28		
Spool Valve Resilient Seal	30		
Pilot Valves	31		
Manifolds	32		
Electrical Accessories	36		

Kuhnke Pneumatic Products.....

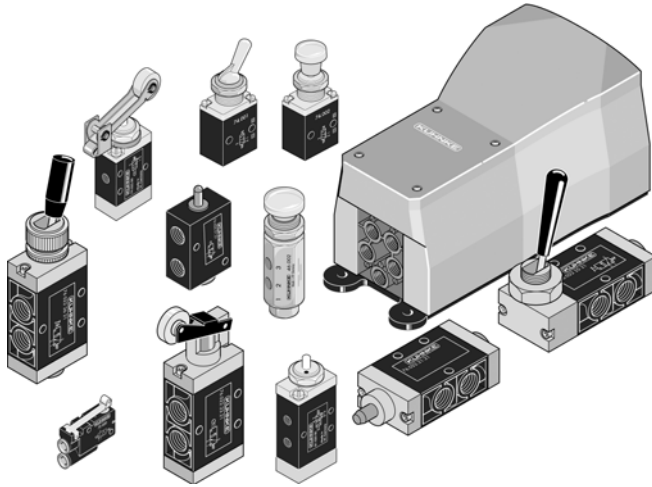

Mechanically and Manually Operated Valves

From micro valves through 1/4 ported, heavy duty foot pedals and just about every type of operator needed to fit your application.

Pneumatically Operated Valves

From low pressure amplifiers to 1/2 inch ported power valves in all types of configurations.

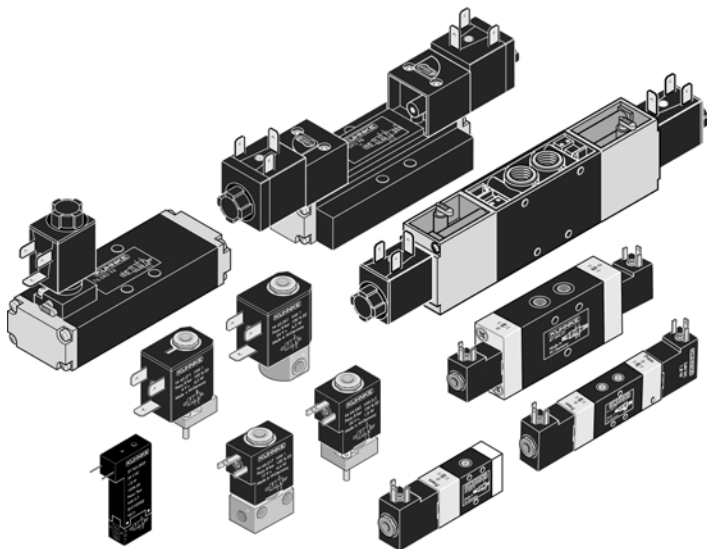
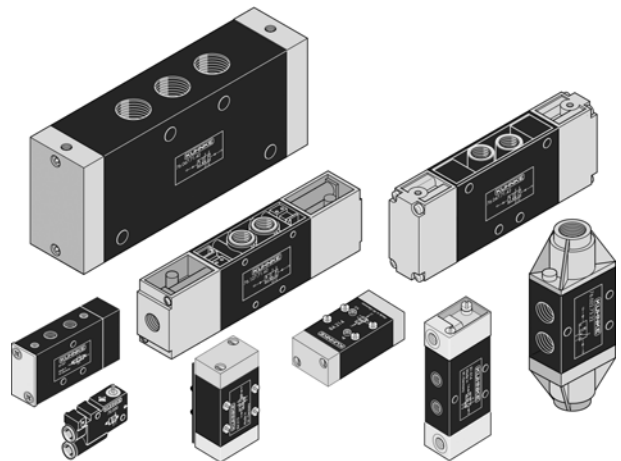

Electrically Operated Valves

A complete line of solenoid operated valves from 10mm wide bodies to 1/2 inch ported sizes. In spool as well as poppet designs.

Cylinders and Rotary Actuators

Cylinders from 1/8 to 8 inch bores in brass, stainless or aluminum designs. Miniature short stroke cylinders and rotary actuators up to power size movers. And cylinders built to ISO 15552 (6431) and other important standards.

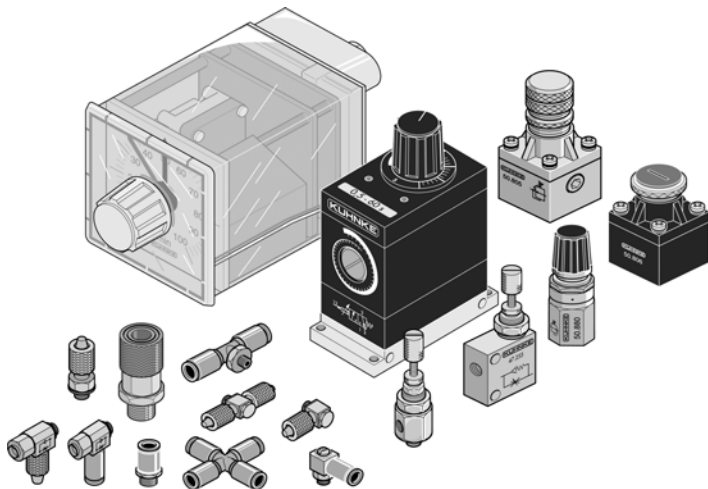
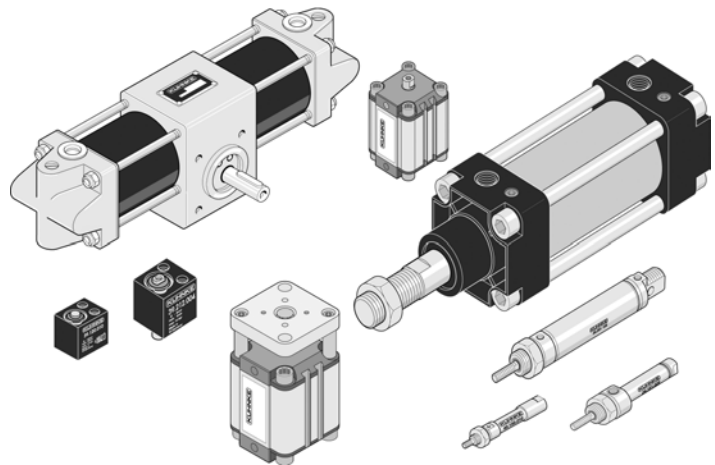

System Accessories

A wide range of pneumatic control system accessories including timers, counters, logic devices, precision regulators, indicators, pressure switches, flow controls and miniature pneumatic fittings.

Electronic/Pneumatic System Components

Valve islands incorporating I/O modules for Profi or CAN-open bus systems. Valve modules for ASi control systems. Smart cylinders incorporating electronics for bus systems and controllers for cylinder load/speed control.

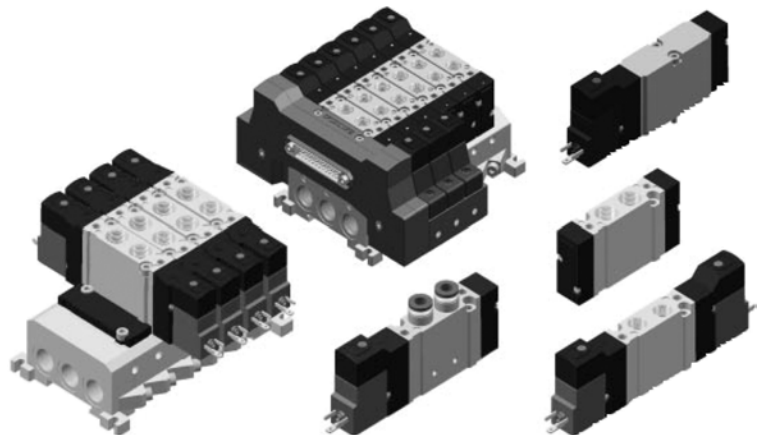

Solenoid Operated Micro Valves

Kuhnke manufactures 2 families of Micro Valves for use in compact devices supplying small volumes of air at fast switching speed and low power consumption. In addition to general purpose use, these valves are especially suitable for medical, dental and laboratory devices. Valves are 3/8 or 5/8 inch (10 and 15mm) wide and are manifold mounted using a modular manifold system providing a compact package that can be easily mounted alongside electronic devices to reduce control package size.

Micro solenoid valves are constructed using a durable plastic material (Pocan) and have encapsulated coils. A number of electrical connection methods can be utilized to customize an installation for easy control hook-up, and valves can be easily interchanged or replaced without long shutdown time. Standard units are designed for 24 volt DC applications. Several versions are available to meet specific flow requirements.

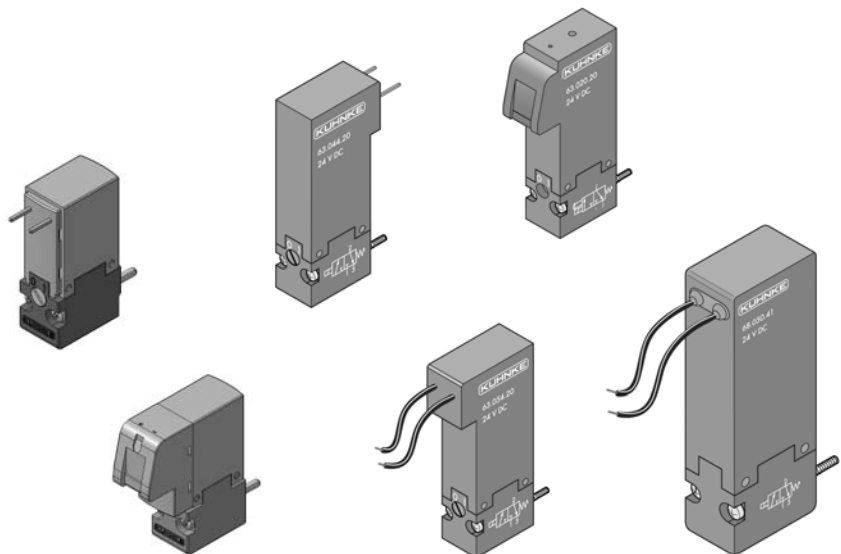

Micro Solenoid Valves

Series 63 – 2 or 3 Way Low Power

Kuhnke Miniature Valves

Micro Solenoid Valves, 10mm Wide (Low Power Version)

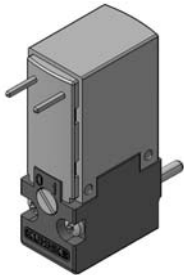

Pin Connector

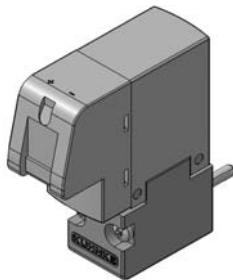

Plug Connector

The Series 63 low power solenoid valve is a manifold mounted 10mm (3/8 inch) wide valve for compact installations where switching small volumes of air or liquids is required. The valve has a power consumption of 1 watt. The power saver version, which includes an electronic circuit built in to the coil body, reduces power consumption to minimum holding current of 0.2 watt.

The Series 63 valve is available with 3 orifice sizes each with different flow values and maximum air pressures. Standard valves are designed for 24 volts DC operation and feature a molded housing, NBR seals, encapsulated coils and are mountable in any position.

Accessories include modular manifolds and connectors.

Options include viton, silicone or EPDM seal materials. A manual operator can be added for testing valve circuits. For a comprehensive list of options see page 15. Pneumatic or electrical modifications can be made to suit specific application requirements.



In addition to general purpose use, Series 63 valves are designed for the special requirements of medical, dental and laboratory equipment. Custom designs available.

Technical Specifications

Operating Pressure:

0 to 145 PSI, see selection chart.

Max. Flow Rate and Pressure:

See selection chart.

Cv/Kv:

See flow graphs.

Connection:

See manifold details.

Media:

All neutral liquid or gaseous media.

Power Consumption:

24VDC, 1W
Optional 12VDC, 1W
Power Saver Coil 0.2W (after 200ms on time)

Valve Operating Time:

Pick-up: 5-10 ms
Drop out: 4-6 ms

Materials:

Molded body POCAN (PBT),
NBR Seals,
Brass inserts.
Optional Viton, Silicone or EPDM seals

Average Mechanical Life:

100 million operations

Operating Ambient:

-10°C to 50°C (12°F to 120°F)

Dimensions (inches):

3/8" W x 1 1/4" H x 1 1/16" D.
(10mm W x 31.2mm H x 26.9mm D)

Flow Graphs in Bar and Liters per Minute

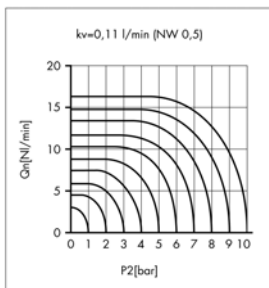

0.5mm Orifice
Cv - .01 / Kv - .11

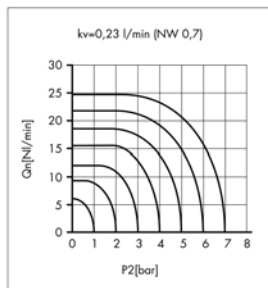

.7mm Orifice
Cv - .015 / Kv - .23

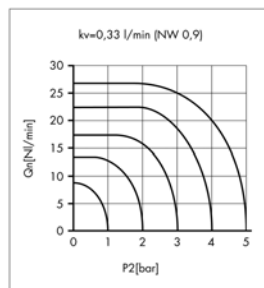

.9mm Orifice
Cv - .075 / Kv - .33

(1 Bar = 14.5 PSI; 1 Liter = .03531 cubic feet)

Micro Solenoid Valves

Kuhnke Miniature Valves

Series 63 – 2 or 3 Way, Low Power

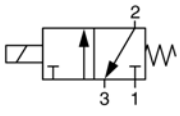
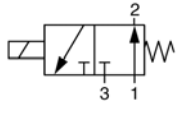

Selection Chart

Description		Plug Socket with LED and Surge Suppressor		Plug Socket with Power Saver Circuit		Pin Connectors (Outboard)	
		Max. Press. and Flow	Catalog Number	Max. Press. and Flow	Catalog Number	Max. Press. and Flow	Catalog Number
3 Way Normally Closed, 24VDC 	Orifice 0.5mm	115 PSI, 0.38 SCFM (8 Bar 11 Liters)	63110-10	145 PSI, 0.60 SCFM (10 Bar 17 Liters)	63120-10	115 PSI, 0.38 SCFM (8 Bar 11 Liters)	63130-10
	Orifice 0.7mm	45 PSI, 0.42 SCFM (3 Bar 12 Liters)	63110-20	105 PSI, 0.88 SCFM (7 Bar 25 Liters)	63120-20	45 PSI, 0.42 SCFM (3 Bar 12 Liters)	63130-20
	Orifice 0.9mm	30 PSI, 0.49 SCFM (2 Bar 14 Liters)	63110-30	60 PSI, 0.77 SCFM (4 Bar 22 Liters)	63120-30	30 PSI, 0.49 SCFM (2 Bar 14 Liters)	63130-30
3 Way Normally Open, 24VDC 	Orifice 0.7mm	45 PSI, 0.42 SCFM (3 Bar 12 Liters)	63111-20	105 PSI, 0.88 SCFM (7 Bar 25 Liters)	63121-20	45 PSI, 0.42 SCFM (3 Bar 12 Liters)	63131-20
	--	--	--	--	--	--	--

For 2 way valve operation using these 3 way valves, see manifold assembly details. For 2 way valves, see catalog system chart on page 15. Standard coil voltage 24 VDC, specify 12 VDC if required.

Coil Options

Plug socket type with LED and surge suppressor- Coil has built in surge protection and visual indicator for on-off status.

Plug socket type with power saver circuit- Coil has built in circuit for reducing power consumption to 0.2 watts after the coil is energized.

Both plug socket types use a plug in connector with wire leads for connection to terminal blocks or other devices. See accessories for wire lengths and catalog numbers.

Pin connector – Valves are equipped with connector pins for direct connections to printed circuit board assemblies or can be used with crimp on wire connectors (ie. AMP No. 925366-3, crimp 167301-4). Pins are 0.64mm square and are spaced 5mm apart. Outboard pins face away from valve ports.

Manifolds and Sub Bases

A modular manifold system is available for constructing custom manifolds for Series 63 valves. A molded single sub base can be used for individually mounting valves. Aluminum manifolds and sub bases are also available. See accessories.

See page 15 for a list of non-standard types of Series 63 valves.

Consult factory for special seals, flow requirements or custom manifold designs including electronic intelligence circuits.

See 63 valve accessories for manifolds and connectors. For detail dimensions contact factory.

Micro Solenoid Valves

Series 63 – 2 or 3 Way Standard

Kuhnke Miniature Valves

Micro Solenoid Valves, 10mm Wide (Standard Version)

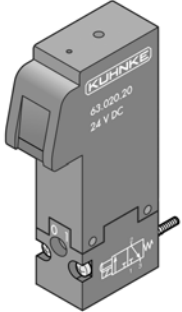

Plug Connector

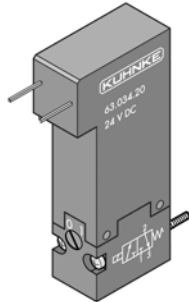

Outboard Pin Connector

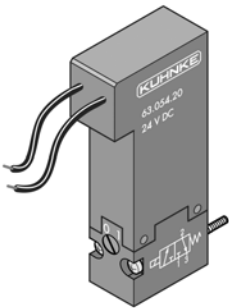

Pigtail Version

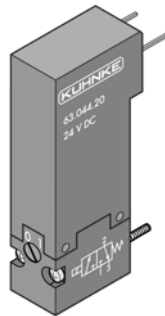

Inboard Pin Connector

The Series 63 solenoid valve is a manifold mounted 10mm (3/8 inch) wide valve with low power consumption, ideal for compact installations where small volumes of air or liquids are required.

The standard valve is available with 3 orifice sizes each with different flow values and maximum air pressures. Valves are designed for 24 volts DC operation and feature a molded housing, NBR seals, encapsulated coils and are mountable in any position.

Accessories include modular manifolds and connectors.

Options include viton, silicone or EPDM seal materials. A manual operator can be added for testing valve circuits. For a comprehensive list of options see page 15. Pneumatic or electrical modifications can be made to suit specific application requirements.



Pneumatics for Life Science

In addition to general purpose use, Series 63 valves are designed for the special requirements of medical, dental and laboratory equipment. Custom designs available.

Technical Specifications

Operating Pressure:

0 to 145 PSI, see selection chart.

Max. Flow Rate and Pressure:

See selection chart.

Cv/Kv:

See flow graphs.

Connection:

See manifold details.

Media:

All neutral liquid or gaseous media.

Power Consumption:

24VDC, 1.8W
Optional 12VDC, 1.8W

Valve Operating Time:

Pick-up: 5-10 ms
Drop out: 4-6 ms

Materials:

Molded body POCAN (PBT),
NBR Seals,
Brass inserts.
Optional Viton, EPDM or Silicone seals

Average Mechanical Life:

100 million operations

Operating Ambient:

-10°C to 50°C (12°F to 120°F)

Dimensions (inches):

3/8" W x 1 5/8" H x 7/8" D.
(10mm W x 42.5mm H x 22.6mm D)

Flow Graphs in Bar and Liters per Minute

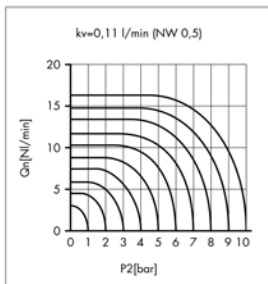

0.5mm Orifice
Cv - .01 / Kv - .11

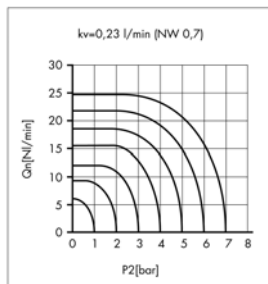

.7mm Orifice
Cv - .015 / Kv - .23

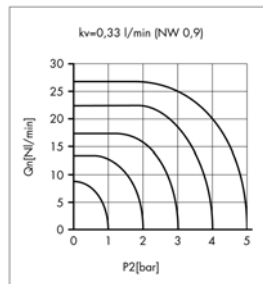

.9mm Orifice
Cv - .075 / Kv - .33

(1 Bar = 14.5 PSI; 1 Liter = .03531 cubic feet)

Selection Chart

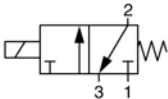
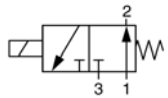

Description	Orifice (Maximum Operating Pressure and Flow)	Catalog Number			
		Plug Socket	With Pigtails	Pin Connector (Outboard)	Pin Connector (Inboard)
3 Way Normally Closed, 24 VDC 	0.5mm (145 PSI, 17 Liter 0.6 CFM)	63020-10	63054-10	63034-10	63044-10
	0.7mm (100 PSI, 25 Liter 0.9 CFM)	63020-20	63054-20	63034-20	63044-20
	0.9mm (75 PSI, 27 Liter 0.95 CFM)	63020-30	63054-30	63034-30	63044-30
3 Way Normally Open, 24 VDC 	0.7mm (100 PSI, 25 Liter 0.9 CFM)	63021-20	63055-20	63035-20	--
	--	--	--	--	--

For 2 way valve operation using these standard valves, see manifold assembly details. Standard coil voltage 24 VDC, specify 12 VDC if required.

Coil Options

Several coil connection versions are available to suit application preferences.

Plug socket type- Uses a plug in connector with wire leads for connection to terminal blocks or other devices. See accessories for catalog numbers and wire lengths.

Pigtails- Valves have 18 inch (500mm) pigtails molded into coil.

Pin connectors – Valves are equipped with connector pins for direct connections to printed circuit board assemblies or can be used with crimp on wire connectors (ie. AMP no. 925366-3, crimp 167301-4). Pins are 0.64mm square and are spaced 7.6mm apart. Outboard pins face away from valve ports while inboard types have pins facing in the same side as valve ports.

Manifolds and Sub Bases

A modular manifold system is available for constructing custom manifolds for Series 63 valves. A molded single sub base can be used for individually mounting valves. Aluminum manifolds and sub bases are also available. See accessories.

See page 15 for a list of non-standard types of Series 63 valves.

Consult factory for special seals, flow requirements or custom manifold designs including electronic intelligence circuits.

See 63 valve accessories for manifolds and connectors. For detail dimensions contact factory.

Micro Solenoid Valves

Series 63 Valve Accessories

Kuhnke Miniature Valves

Modular Manifolds

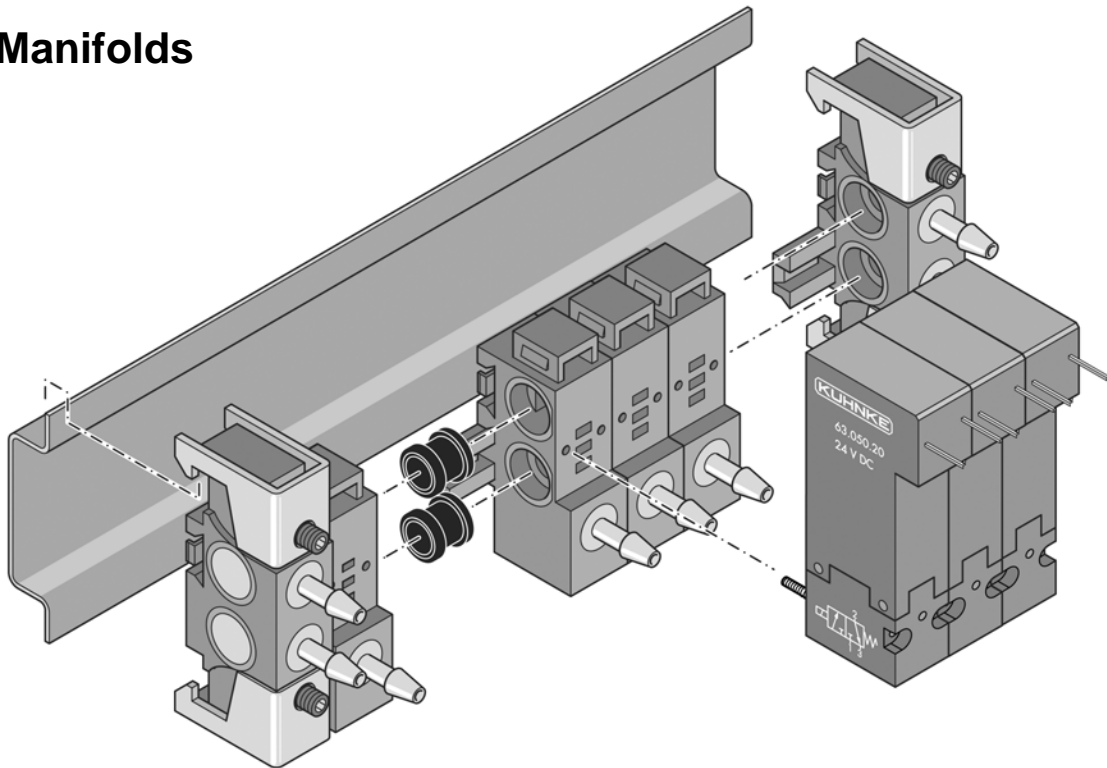

Manifold Assembly,
DIN Rail Version with
Standard Size Valves

Series 63 Modular Manifolds can be built up to suit specific installation requirements. Components are available in 2 versions: for DIN rail, or surface mounting. Component sections consist of inlets, endplates, center supports, center inlets as well as valve bases. Special grommets, included with each module, are inserted between units to form a seal for internal common air supply and exhaust lines. Tabs at the bottom of each module interlock with adjacent sections to form the manifold. The module assembly is secured by tightening screws on the end modules to the panel surface or DIN rail.

Normally closed or normally open valve functions are achieved by assembling the valve bases in specific positions on the manifold, see manifold assembly notes.

Intermediate air supply modules and seal barriers can be used to construct manifolds with several air supply sources.

All air connections have barb fittings for 3mm (1/8) I.D. tubing.

Valves are assembled on the built up manifold using a special seal and screws supplied in the valve package.

Electrical connections are dependent on the type of valve coil design selected.

Custom manifolds can be factory assembled for OEM applications.

Dimensions

Approximate manifold dimensions, including the standard size valves mounted, are 1 3/8" (35mm) deep x 2 5/32" (55mm) high x length. To determine length, add 3/8" (10mm) for each module used in the assembly.

Modules are molded from POCAN, seals NBR, and have brass inserts for end caps and tube connections. The use of an intermediate support is recommended for each 8 valve positions on the manifold.

Modular Manifolds—Valve Base Sections

- Base for 3 Way N.C. or N.O. Valve **63071-00**
- Base for 2 Way N.C. Valve **63071-10**
- Base for 2 Way N.O. Valve **63071-20**

Manifold valve base sections are available in 3 versions to meet valve application requirements. Three way valves are used in conjunction with these bases to provide 2 or 3 way operation. The position of the valve base on the manifold determines the N.O. or N.C. function. See manifold assembly notes on the next page.

Valve bases are used for both DIN rail or surface mounted manifolds.

Sections are molded material and include a brass barb fitting for 1/8" (3mm) I.D. tubing. Each base has interlocking tabs for snap on connection to the manifold assembly and includes 2 grommet seals for the common input and exhaust channels. Valves are mounted on the bases with the use of 2 special self-tapping screws and gasket included in the valve package.

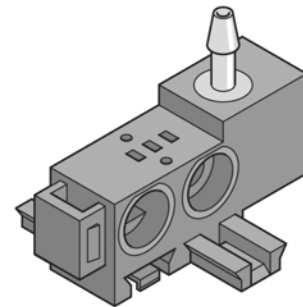

3 Way
Valve Base

Modular Manifolds- Headers, Center Supports, Endplates (For DIN Rail Mounting)

- Common Input and Exhaust Module (Header) **63076-00**
- End Plate **63079-00**
- Intermediate Input Module **63076-10**
- Middle Support Module **63079-10**

Rail mounting modules are supplied with clips and fastening screws to mount manifold assemblies on standard DIN rails. All modules have interlocking tabs for assembling custom manifolds and include 2 sealing grommets. Input modules have brass barb fittings for 1/8" (3mm) I.D. tubing for connection of common air supply and exhaust lines.

An intermediate input module can be used to provide an additional air supply on large manifold assemblies, or with the use of a blocking grommet cat. no. 64390-02, can be used to isolate the manifold section for connection of a separate air supply.

The middle support module should be used to support the manifold between every 8 valve bases used on the manifold assembly.

An end plate is required to close off the manifold.

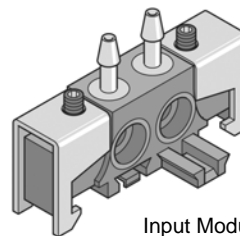

Input Module

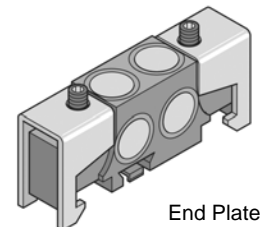

End Plate

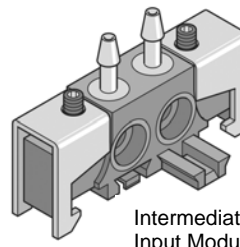

Intermediate
Input Module

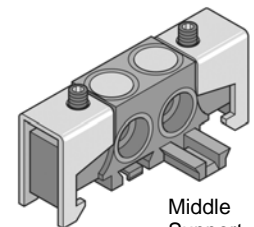

Middle
Support

Micro Solenoid Valves

Series 63 Valve Accessories

Kuhnke Miniature Valves

Modular Manifolds- Headers, Center Supports, Endplates

(For Surface Mounting)

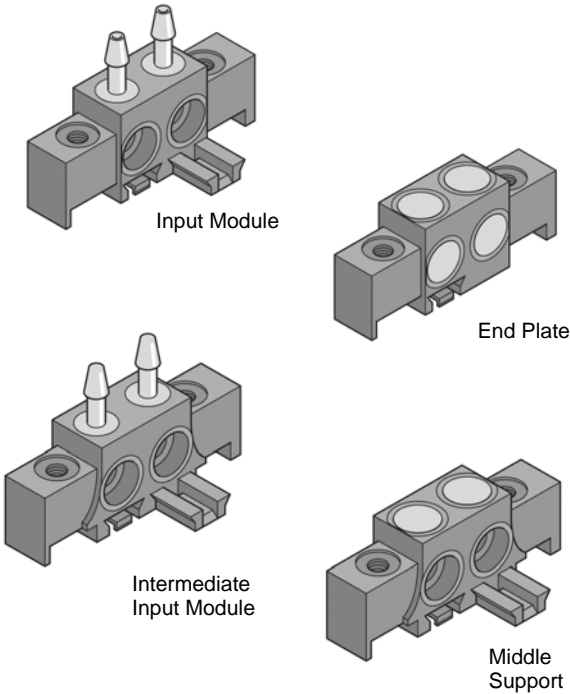

63086-00 Common Input and Exhaust Module (Header)

63089-00 End Plate

63086-10 Intermediate Input Module

63089-10 Middle Support Module

Surface mounting modules have 2 mounting holes on 1 7/32" centers for #4 (or M3) screws to attach manifolds to panel surfaces. All modules have interlocking tabs for assembling custom manifolds and include 2 sealing grommets.

Input modules have brass barb fittings for 1/8" (3mm) I.D. tubing for connection of common air supply and exhaust lines.

An intermediate input module can be used to provide an additional air supply on large manifold assemblies, or with the use of a blocking grommet cat. no. 64390-02, can be used to isolate the manifold section for connection of a separate air supply.

The middle support module should be used to support the manifold between every 8 valve bases used on the manifold assembly.

End plates are used to close off the manifold.

Manifold Assembly Notes

The basic manifold assembly consists of a header for supply air and exhaust connections, bases to mount valves and an end plate to close off the manifold.

Valve bases must be assembled in specific positions on the manifold to obtain normally open or normally closed functions. For all *Normally Closed* functions the tube connection for port 2 will be at the bottom. For *Normally Open* functions the base is mounted with the tube connection at the top of the manifold (180° opposite).

The illustration shows the variations for mounting valve bases.

Dimensions

Manifold dimensions, including the standard valves mounted, are 1 3/8" (35mm) deep x 2 5/32" (55mm) high x length. To determine length, add 3/8" (10mm) for each module used in the assembly (include header, end plate and all intermediate modules).

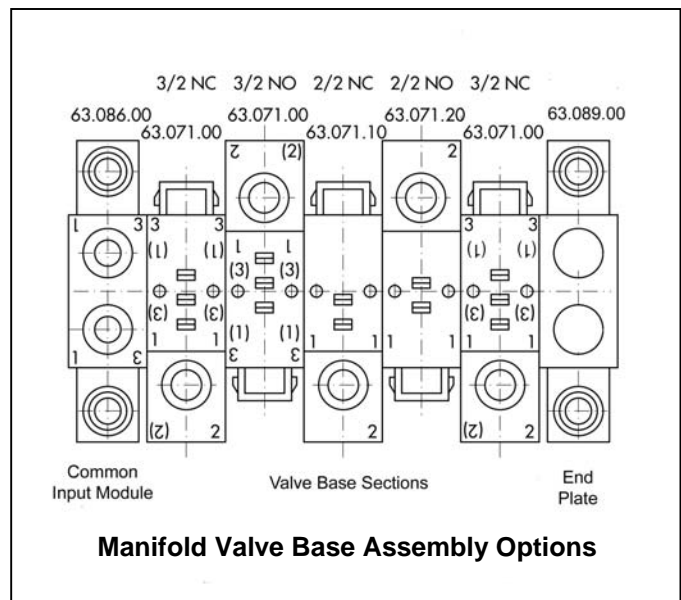

Manifold Valve Base Assembly Options

Single Sub Base

Molded Sub Base 63091-41

A molded sub base can be used for surface mounting a single 3 way valve. The base includes brass barb fittings for 1/8" (3mm) I.D. non-rigid tubing. Dimensions (including valve mounted) are 1 1/4" H. x 1 5/8" L x 1" W. Two mounting holes for #4 (or M3) screws on 5/8" centers are used to mount the base. Valves are mounted on the base using the special self-tapping screws supplied in the valve package.

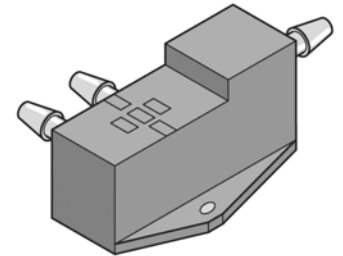

An aluminum sub base, (catalog no. **86406-01** -not shown) is also available for mounting single valves. The base has ports for M3 fittings and has 2 mounting holes for #4 (or M3) screws. Valve mounting screws are self-tapping type for metal and are included with the base.

Aluminum Manifolds

Aluminum manifolds are available to mount 3 way normally closed Series 63 valves. Units are constructed of aluminum bar stock with 10-32 (M5) supply ports at each end and metric M3 output ports along valve stack. Manifolds are all pre-drilled to allow valves to be mounted side by side without intermediate spacing. Standard manifolds are available for 2, 3 or 4 station configurations. Mounting is via a 1/8" screw hole at each end of the manifold. Valve mounting screws are self-tapping type for metal and are included with the manifold.

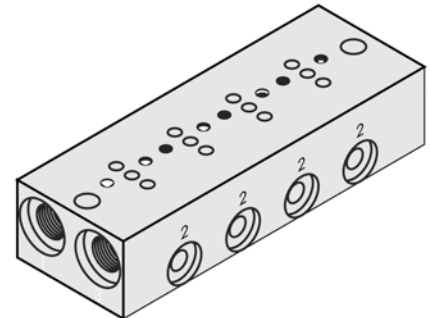

Number of Stations	Dimensions 3/4"W x 1/2"H x L Dim Below	Catalog Number
2	1 1/4"	86406-02
3	1 11/16"	86406-03
4	2 1/8"	86406-04

Drilling Plan for Custom Manifolds

Valves can be mounted with 10.5mm (.413 inch) spacing between centers. Mounting holes should be tapped for 1.6mm x 18 metric thread for machine screws. A self-tapping screw is also available. Screws supplied with valves are used for molded modular manifolds. For other screws see next page. Ports are centered and are numbered 3, 2, 1 from top to bottom.

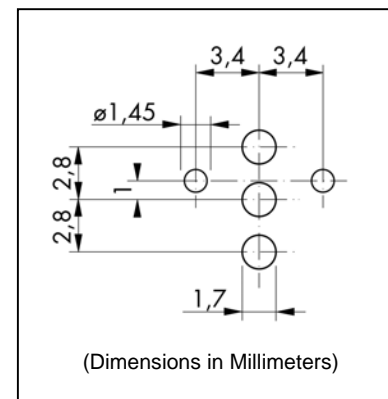

Micro Solenoid Valves

Series 63 Valve Accessories

Kuhnke Miniature Valves

Electrical Connectors

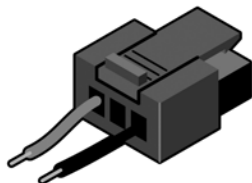

MPP91130-36-00 Connector, 1 foot (300mm) leads (Pack of 10)

MPP91130-39-00 Connector, 6 foot (2000mm) leads (Pack of 10)

Connectors are designed for use with Series 63 valves equipped with a plug socket. Wires are color coded for easy identification and connectors are available with 2 different wire lengths. Connector snaps on to coil and can be easily disconnected by pressing a release tab on the top of the plug.

Blanking Cap

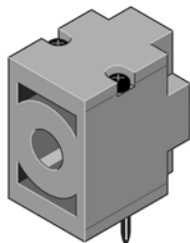

63095-00

Blanking caps are used to block ports on an unoccupied valve base. Used when manifolds are constructed with positions for future valves. Constructed of the same molded material as the manifold, the cap includes a gasket and 2 special screws for mounting on the modular valve base.

Blocking Grommet



64390-02 (Pack of 50)

A barrier is used in place of the standard sealing grommet between manifold modules to block off common input and exhaust ports when constructing manifolds with different air supply sources.

Special Mounting Hardware



63100-02 Metric thread 1.6 x 18 Machine Screw (Pack of 100)

Special size machine screws are used for mounting valves on custom made metal manifolds with tapped holes. See spare parts below for self-tapping screws.

Spare Parts

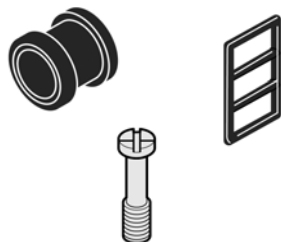

64390-01 Sealing Grommet (Pack of 50)

63230-02 Valve Seal (Pack of 50)

63100-00 Valve Mounting Screw, Self-tapping, for Aluminum Manifolds (Pack of 100)

63100-01 Valve Mounting Screw, Self-tapping, for Modular Manifolds (Pack of 100)

Series 63 Cataloging System

The chart below includes standard and optional types of valves. For standard types, see the catalog pages. Contact factory for information about other possible valve combinations. Not all combinations in this chart are possible.

Typical Catalog Number →	63	05	4-	2	0
Valve Series Number –	63				
Solenoid Design –					
Standard 1.8W coil w/plug, electrical connection left, pneumatic ports right side.		02			
Standard 1.8W coil w/pins, electrical connection left, pneumatic ports right side.		03			
Standard 1.8W coil w/pins, electrical connection right, pneumatic ports right side.		04			
Standard 1.8W coil w/pigtails, electrical connection left, pneumatic ports right side.		05			
Standard 1.8W coil w/pigtails, electrical connection right, pneumatic ports right side.		06			
Low Power, 1 W coil w/plug, LED and surge suppressor, electric left, pneumatic ports right side.		11			
Low Power, 1 W, coil w/plug and power saver circuit, electric left, pneumatic ports right side.		12			
Low Power, 1 W coil w/pins, electrical connection left, pneumatic ports right side.		13			
Low Power, 1 W coil w/pins, electrical connection right, pneumatic ports right side.		14			
Function –					
3 Way NC without manual operator			0		
3 Way NO without manual operator			1		
2 Way NC without manual operator			2		
2 Way NO without manual operator			3		
3 Way NC with manual operator			4		
3 Way NO with manual operator			5		
2 Way NC with manual operator			6		
2 Way NO with manual operator			7		
Orifice –					
0.3mm				0	
0.5mm				1	
0.7mm				2	
0.9mm				3	
1.0mm				4	
0.4mm				5	
1.2mm				6	
Valve Seals –					
NBR (Std)					0
Viton					1
EDPM					2
Silicone					3

Micro Solenoid Valves

Series 68 – 3 Way

Kuhnke Miniature Valves

Micro Solenoid Valves (15mm Wide)

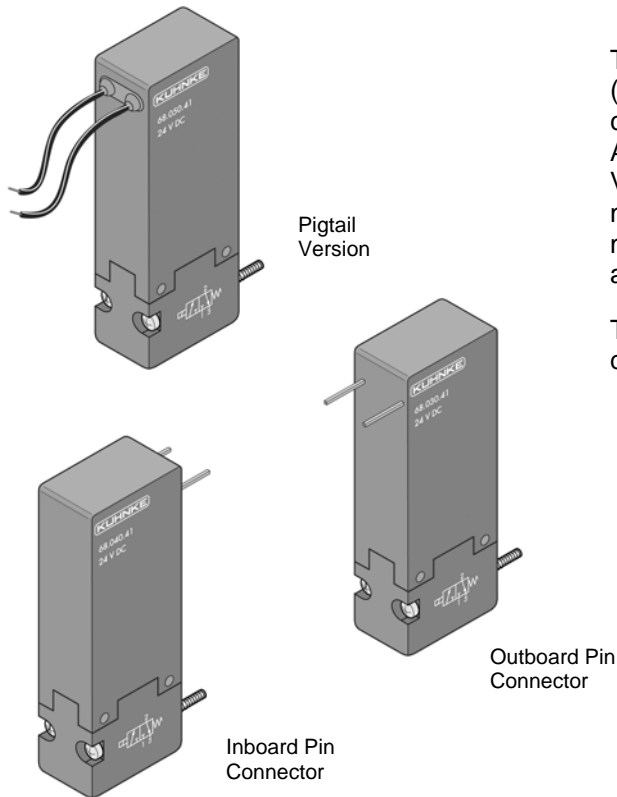

The Series 68 solenoid valve is a manifold mounted 15mm (5/8 inch) wide valve with low power consumption, ideal for compact installations where small volumes of air are required. Accessories include modular manifolds and connectors. Valves are designed for 24 volts DC operation and feature a molded housing, viton seals, encapsulated coils and are mountable in any position. Optional seal materials are available.

The Series 68 valve is available with 3 orifice sizes each with different flow values and maximum air pressures.



In addition to general purpose use, Series 68 valves are designed for the special requirements of medical, dental and laboratory equipment. Custom designs available.

Technical Specifications

Operating Pressure:

0 to 145 PSI, see selection chart.

Max. Flow Rate and Pressure:

See selection chart.

Cv/Kv:

See flow graphs.

Connection:

See manifold details.

Media:

All neutral gaseous media.

Power Consumption:

24VDC, 3 W
Optional 12VDC, 3 W

Valve Operating Time:

Pick-up: 5-10 ms
Drop out: 3-5 ms

Materials:

Molded body Pocan (PBT),
Viton (FKM) Seals,
Brass inserts.
Optional NBR or EPDM seals

Average Mechanical Life:

20 million operations

Operating Ambient:

-10°C to 50°C (12°F to 120°F)

Dimensions (inches):

5/8" W x 2 1/2" H x 1" D.
(15mm W x 64mm H x 24mm D)

Flow Graphs in Bar and Liters per Minute

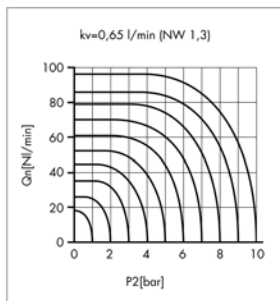

1.3mm Orifice
Cv - ..045 / Kv - .65

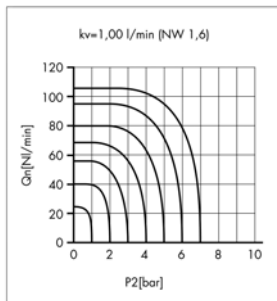

1.6mm Orifice
Cv - .07 / Kv - 1

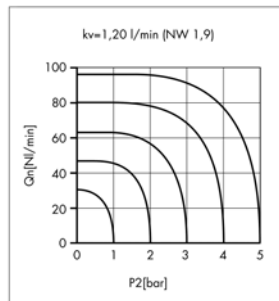

1.9mm Orifice
Cv - .085 / Kv - 1.2

(1 Bar = 14.5 PSI; 1 Liter = .03531 cubic feet)

Selection Chart

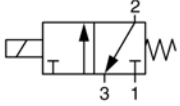

Description	Orifice (Maximum Operating Pressure and Flow)	Catalog Number		
		With Pigtails	Pin Connector (Outboard)	Pin Connector (Inboard)
3 Way Normally Closed, 24 VDC 	1.3mm (145 PSI, 95 Liter 3.3 CFM)	68050-41	68030-41	68040-41
	1.6mm (100 PSI, 105 Liter 3.7 CFM)	68050-01	68030-01	68040-01
	1.9mm (75 PSI, 95 Liter 3.3 CFM)	68050-51	68030-51	68040-51

Standard coil voltage 24 VDC, specify 12 VDC if required.

Coil Options

Several coil connection versions are available to suit application preferences.

Pigtails- Valves have 18 inch (500mm) pigtails molded into coil.

Pin connectors – Valves are equipped with connector pins for use with electrical connector cat. no. 68135 (see accessories) or for direct connections to printed circuit board assemblies. Pins are 0.64mm square and are spaced 10.2mm apart. Outboard pins face away from valve ports while inboard types have pins facing in the same side as valve ports.

Manifolds

Standard manifolds are available with up to 8 stations for Series 68 valves. The manifold is constructed of molded POCAN and is equipped with push in connectors for 1/4 inch O.D. tubing.

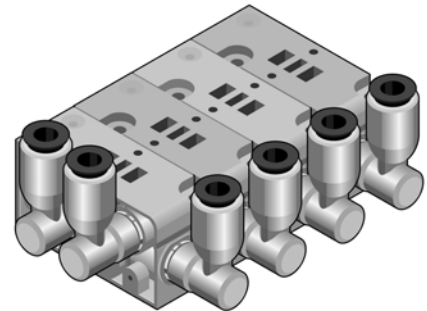

Number of Stations	Dimensions 1 7/8"W x 1 3/8"H x L Dim Below	Catalog Number
1	5/8"	68240-01
2	1 1/4"	68240-02
3	1 13/16"	68240-03
4	2 3/8"	68240-04
5	3"	68240-05
6	3 5/8"	68240-06
7	4 1/4"	68240-07
8	4 13/16"	68240-08

Consult factory for special seals, flow requirements or custom manifold designs including electronic intelligence circuits.
See Valve accessories for manifolds and connectors. For detail dimensions contact factory.

Micro Solenoid Valves

Series 68 Valve Accessories

Kuhnke Miniature Valves

Electrical Connectors

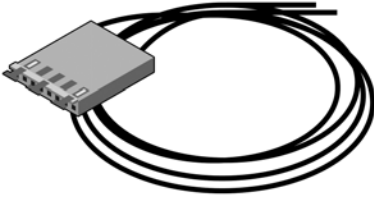

68135 Connector, 18 inch (500mm) leads (Package of 10)

Connectors are designed for use with Series 68 valves equipped with pin connectors. Wires are color coded for easy identification.

Blanking Cap

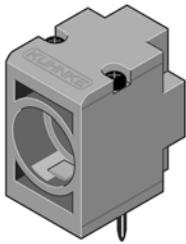

68201-00

Blanking caps are used to block ports on an unoccupied valve base. Used when manifolds are constructed with positions for future valves. Constructed of the same molded material as the manifold, the cap includes a gasket and 2 special screws for mounting on the modular valve base.

Spare Parts



68230-01 Valve gaskets (Pack of 50)

68110-00 Mounting Screw (pack of 100)

68110-01 Machine Screw M2.5 x 28 (pack of 100)

Valves are supplied with a sealing gasket and mounting screws for molded manifolds.

Spare gaskets are available to provide the seal between the valve and manifold. Mounting screws for use on plastic manifolds are available in packages of 100 and a machine screw for mounting Series 68 valves on custom manifolds can be used on custom metal manifolds.

Solenoid Operated Miniature Valves

Solenoid Operated Miniature Valves are available in 2 or 3 way poppet designs as well as 3 or 4 way spool and sleeve designs. Valves have either 10/32 (M5) or 1/8 porting. Most valves have been designed for the special requirements of medical, dental and laboratory equipment. Custom designs are available for unusual applications.

Two or three way poppet valves are constructed of a brass base with stainless steel stems and encapsulated coils. Valves are designed for compact mounting and have several mounting configurations.

Three or four way spool and sleeve valves are compact and provide long life cycles. Constructed with an aluminum body, stainless spool and sleeve and have encapsulated coils.

Two types of molded pilot valves are also available for switching small volumes of air needed for remote piloting of other valves or devices.

Accessories include sub bases, manifolds and electrical connectors.

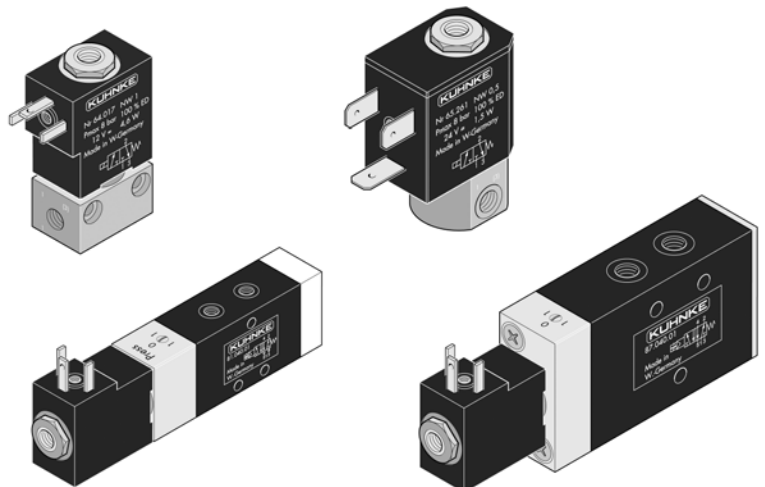

Miniature Solenoid Valves

Series 64 – 2 or 3 Way

Kuhnke Miniature Valves

Miniature Solenoid Valves (16mm Wide)

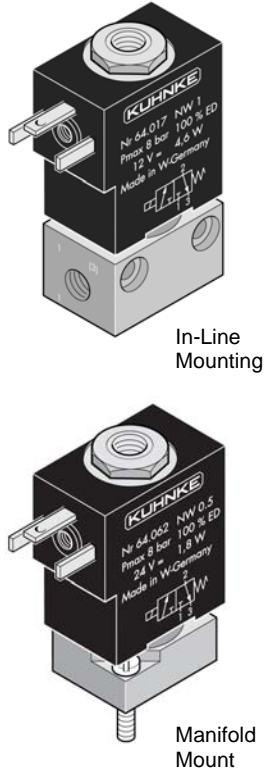

The Series 64 solenoid valve is available for in-line, direct or manifold mounting. Its modular construction allows for maximum utilization of space. Accessories include connecting plugs, surge suppressors and manifolds. All standard valves feature a solid brass housing, buna N seals, encapsulated coils and are mountable in any position.

Valves are available in 3 mounting configurations. In-line (body ported) valves are mounted using (2) M3 threaded holes at the base, or via through body holes. Manifold mounted valves can be used with Kuhnke accessories or can be mounted on custom manifolds or equipment. A direct mounted valve is available for mounting in 1/8 ports on cylinders or for piloting larger valves.

The Series 64 valve is available with 3 orifice sizes each with different flow values and maximum air pressures. A low power DC coil version (1.8 W) has a 0.5mm orifice and is designed for use with electronic equipment.



In addition to general purpose use, Series 64 valves are designed for the special requirements of medical, dental and laboratory equipment. Custom designs available.

Technical Specifications

Operating Pressure:
90% vacuum to 115 PSI max.
Max. Flow Rate and Pressure:
See selection chart.

Cv/Kv:
See flow graphs.
Connection:
10-32 (M5) ports

Media:
All neutral liquid and gaseous media.
Power Consumption:
Standard: DC: 4.6 W / AC: 5.5 VA
Low Power: DC: 1.8 W

Valve Operating Time:
Pick-up: 5-10 ms
Drop out: 3-5 ms

Materials:
Brass body, Buna N Seals, encapsulated coil.

Average Mechanical Life:
20 million operations

Operating Ambient:
-10°C to 50°C (12°F to 120°F)

Dimensions (inches):

	In Line	Manif.	Direct
Height	1 7/8	1 5/8	2 5/32
Width	5/8	5/8	5/8
Depth	1 1/16	1 1/16	1 1/16
Weight	3 oz.	2.5 oz.	3.2 oz.

Flow Graphs in Bar and Liters per Minute

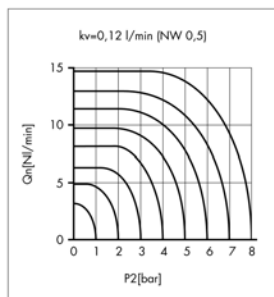

0.5mm Orifice
Cv - .01 / Kv - .12

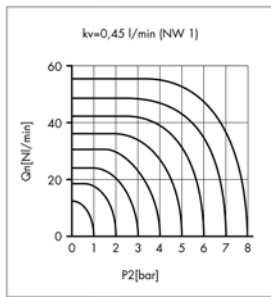

1mm Orifice
Cv - .03 / Kv - .45

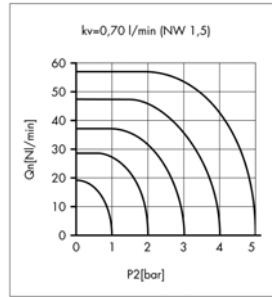

1.5mm Orifice
Cv - .05 / Kv - .70

(1 Bar = 14.5 PSI; 1 Liter = .03531 cubic feet)

Miniature Solenoid Valves

Kuhnke Miniature Valves

Series 64 – 2 or 3 Way

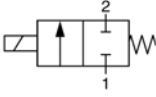
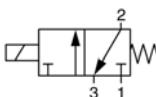
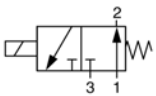
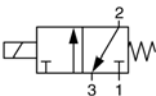

Selection Chart

Description	Orifice (Maximum Operating Pressure and Flow)	Coil Type	Catalog Number					
			In-Line Mounted		Manifold Mounting		1/8 Port Mounting	
			DC Coil	AC Coil	DC Coil	AC Coil	DC Coil	AC Coil
2 Way Normally Closed 	1.5mm (75 PSI, 2.0 CFM)	plug	64073- ●	64072- ●	64076- ●	64075- ●	--	--
		wire	64074- ●	--	64077- ●	--	--	--
	1mm (115 PSI, 2.0 CFM)	plug	64025- ●	64024- ●	64027- ●	64026- ●	--	--
		wire	64047- ●	--	64049- ●	--	--	--
3 Way Normally Closed 	1.5mm (75 PSI, 2.0 CFM)	plug	64054- ●	64053- ●	64056- ●	64055- ●	--	--
		wire	64070- ●	--	64071- ●	--	--	--
	1mm (115 PSI, 2.0 CFM)	plug	64001- ●	64002- ●	64009- ●	64008- ●	64015- ●	64014- ●
		wire	64029- ●	--	64031- ●	--	64069- ●	--
3 Way Normally Open 	1.5mm (60 PSI, 1.7 CFM)	plug	64065- ●	64066- ●	64067- ●	64068- ●	--	--
		wire	64064- ●	--	--	--	--	--
	1mm (115 PSI, 2.0 CFM)	plug	64017- ●	64016- ●	64062- ●	64063- ●	--	--
		wire	64045- ●	--	--	--	--	--
3 Way Normally Closed Low Power Coil 	0.5mm (115 PSI, 0.5 CFM)	plug	64011- ●	--	64013- ●	--	--	--
		wire	64060- ●	--	64061- ●	--	--	--
	--	--	--	--	--	--	--	--
		--	--	--	--	--	--	--

● - Insert coil voltage required to complete catalog number. Standard voltages are 12 and 24 VDC; 24, 110 and 230 VAC.

Coil Types

Coils are available for a plug socket or with wire leads molded into coil (18" pigtails). For socket connectors see accessory section.

For 2 way operation of any 64 Series valve, plug exhaust port 3.

Consult factory for special mounting configurations, flow requirements or different seal materials.

See miniature solenoid valve accessories for electrical connectors and manifolds. For detail dimensions contact factory.

Miniature Solenoid Valves

Series 65 – 2 or 3 Way

Kuhnke Miniature Valves

Miniature Solenoid Valves (22mm Wide)

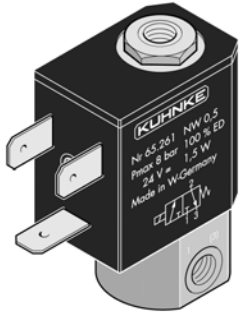

In-Line Mounting

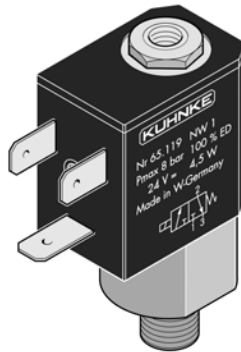

Direct Mounting

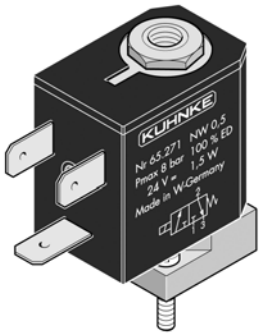

Manifold Mount

The Series 65 solenoid valve is available for in-line, direct or manifold mounting. Accessories include connecting plugs, sub-bases and manifolds. All standard valves feature a solid brass housing, buna seals, encapsulated coils and are mountable in any position.

Types: Standard valves are available in 3 mounting configurations. In-line (body ported) valves are mounted using (2) M3 threaded holes on the underside of the base. Manifold mounted valves can be used with Kuhnke accessories or can be mounted on custom manifolds or equipment. A direct mounted valve is available for mounting in 1/8" ports on cylinders or for piloting larger valves.



In addition to general purpose use, Series 65 valves are designed for the special requirements of medical, dental and laboratory equipment. Custom designs available.

Technical Specifications

Operating Pressure:

90% Vacuum up to 115 PSI max.

Max. Flow Rate and Pressure:

See selection chart.

Cv/Kv:

See flow graphs.

Connection:

10-32 (M5) ports

Media:

All neutral liquid and gaseous media.

Power Consumption:

Standard: DC: 4.5 W / AC: 5 VA

Low Power: DC: 1.5 W

Valve Operating Time:

Pick-up: 10 to 15 ms

Drop out: 3 to 5 ms

Materials:

Brass body, Buna N Seals, encapsulated coil.

Average Mechanical Life:

20 million operations

Operating Ambient:

-10°C to 60°C (12°F to 140°F)

Dimensions (inches):

	In Line	Manif.	Direct
Height:	1 7/8	1 5/8	2 5/32
Width:	13/16	13/16	13/16
Depth:	1 11/16	1 11/16	1 11/16
Weight	4 oz.	3.4 oz.	4.1 oz.

Flow Graphs in Bar and Liters per Minute

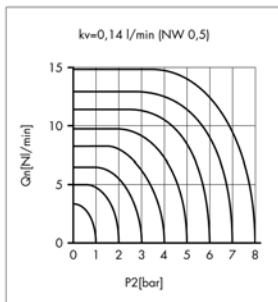

0.5mm Orifice
Cv - .01 / Kv - .14

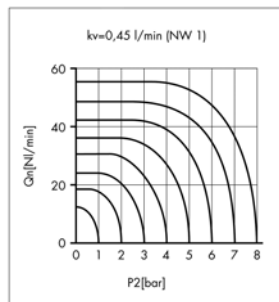

1mm Orifice
Cv - .03 / Kv - .45

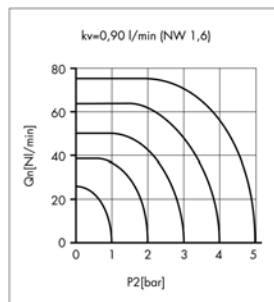

1.6mm Orifice
Cv - .06 / Kv - .9

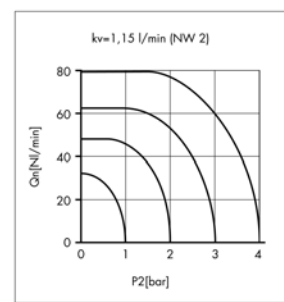

2mm Orifice
Cv - .08 / Kv - 1.15

(1 Bar = 14.5 PSI; 1 Liter = .03531 cubic feet)

Miniature Solenoid Valves

Kuhnke Miniature Valves

Series 65 – 2 or 3 Way

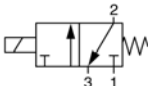
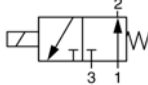
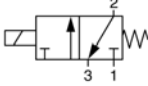

Selection Chart

Description	Orifice (Maximum Operating Pressure and Flow)	Catalog Number					
		In-Line Mounted		Manifold Mounting		1/8 Port Mounting	
		DC Coil	AC Coil	DC Coil	AC Coil	DC Coil	AC Coil
3 Way Normally Closed 	1mm (115 PSI, 2 CFM)	65111- •	65112- •	65127- •	65128- •	65119- •	65120- •
	1.6mm (75 PSI, 2.7 CFM)	65171- •	65172- •	65173- •	65174- •	65175- •	65176- •
	2mm (45 PSI, 2.2 CFM)	65231- •	65232- •	65235- •	65236- •	--	--
3 Way Normally Open 	1mm (90 PSI, 1.5 CFM)	65113- •	65114- •	65123- •	65124- •	--	--
	2mm (60 PSI, 2.8 CFM)	65233- •	65234- •	65237- •	65238- •	--	--
3 Way Normally Closed Low Power Coil 	0.5mm (115 PSI, .5 CFM)	65261- •	--	65271- •	--	--	--
	--	--	--	--	--	--	--

• - Insert coil voltage required to complete catalog number. Standard voltages are 12 and 24 VDC; 24, 110 and 230 VAC.

Pre-assembled Sub Base Valves

Assembled valves on single or double sub bases are available. Valves are 3 way normally closed with a 1mm orifice, max. pressure -115 PSI and have flows of 2 CFM.

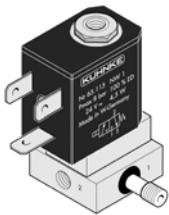

65115- • (DC)
65116- • (AC)

The single valve assembly can be used to build valve banks with the use of a connecting nipple (cat no. **560.100.040.020**) and 2 'O' rings (cat. no. **65412**).

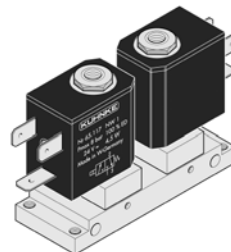

65117- • (DC)
65118- • (AC)

Double sub base valves have ports out the bottom of a metal sub base that fits on manifolds for series 81/83 or 84 valves.

UL versions are available on special order.

For 2 way operation of any 65 Series valve, plug exhaust port 3.

Consult factory for valves with special mounting configurations, flow requirements or different seal materials.

See miniature solenoid valve accessories for electrical connectors and manifolds. For detail dimensions contact factory.

Miniature Solenoid Valves

Series 67 – 2 or 3 Way

Kuhnke Miniature Valves

Series 67 – Miniature Solenoid Valves (30mm Wide)



In Line Mounting

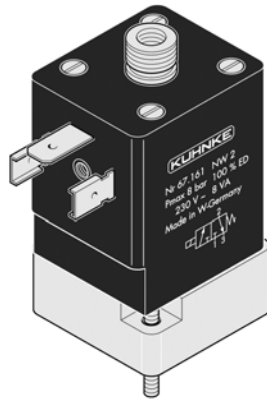

Manifold Mount

The Series 67 solenoid valve is available for in-line or manifold mounting. Its modular construction allows for maximum utilization of space. The valve is available with standard plug terminals. Accessories include connecting plugs, and manifolds. All in line valves feature a solid brass housing, buna seals, encapsulated coils and are mountable in any position. Manifold mounted valves have a cast zinc alloy base.

The Series 67 is available with a manual override option for ease in testing or troubleshooting pneumatic circuits.

Types: Standard valves are available in 2 mounting configurations. In-line (body ported) valves are mounted using 2 (M5) threaded holes at the base. Manifold mounted valves can be used with Kuhnke accessories or can be mounted on custom manifolds or equipment.

Technical Specifications

Operating Pressure:

90% vacuum to 115 PSI

Flow Rate:

Standard: 7 CFM @ 100 PSI

Low Power: 2 CFM @ 100 PSI

Cv/Kv:

See flow graphs.

Connection:

1/8 NPT or Metric

Orifice:

Standard – 2mm

Low Power – 1mm

Media:

All neutral liquid and gaseous media.

Power Consumption:

Standard: DC: 6.5W / AC: 8 VA

Low Power: DC: 1.5W

Valve Operating Time:

Standard: Pick-up: 6-12 ms

Drop out: 6-13 ms

Low Power: Pick-up: 25-30 ms

Drop out: 9-12 ms

Materials:

Brass body, Buna N seals, encapsulated coil. (Manifold mount valves have zinc body.)

Average Mechanical Life:

20 million operations

Operating Ambient:

-10°C to 50°C (12°F to 120°F)

Dimensions (inches):

	In Line	Manifold
Height	2 13/16	2 1/2
Width	1 3/16	1 3/16
Depth	1 3/16	1 3/16
Weight:	10.5 oz.	8 oz.

Flow Graphs in Bar and Liters per Minute

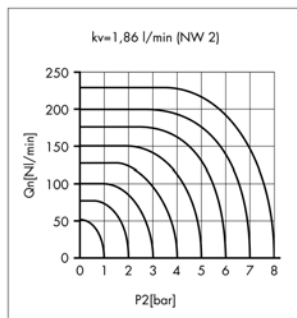

Standard
2mm Orifice
Cv - .13 / Kv -1.86

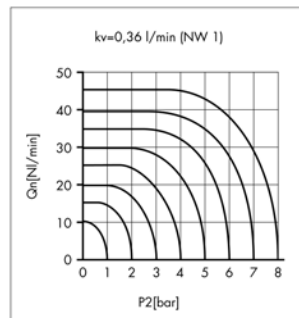

Low Power
1mm Orifice
Cv - .01 / Kv -0.02



(1 Bar = 14.5 PSI; 1 liter = .03531 cubic feet)

Miniature Solenoid Valves

Kuhnke Miniature Valves

Series 67 – 2 or 3 Way

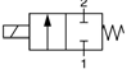
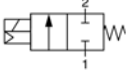
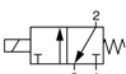
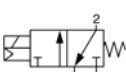
Selection Chart

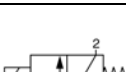
Description		Catalog Number					
		In-Line Mounted				Manifold Mounting	
		DC Coil		AC Coil		DC Coil	AC Coil
		NPT Ports (USA Std.)	Metric Ports (Euro. Std.)	NPT Ports (USA Std.)	Metric Ports (Euro. Std.)		
2 Way Norm. Closed		--	67131- ●	--	67130- ●	67133- ●	67132- ●
2 Way Norm. Closed Manual Override		--	67135- ●	--	67134- ●	67137- ●	67136- ●
3 Way Norm. Closed		67105- ●	67101- ●	67104- ●	67100- ●	67121- ●	67120- ●
3 Way Norm. Closed Manual Override		67115- ●	67111- ●	67114- ●	67110- ●	67123- ●	67122- ●
3 Way Norm. Open		67107- ●	67103- ●	67106- ●	67102- ●	67109- ●	67108- ●
3 Way Norm. Open Manual Override		67117- ●	67113- ●	67116- ●	67112- ●	67119- ●	67118- ●
3 Way Norm. Closed Low Pwr. Coil		67152- ●	67151- ●	--	--	67161- ●	--

● - Insert coil voltage required to complete catalog number. Standard voltages are 12 and 24 VDC; 24, 110 and 230 VAC.

Notice:
 Series 67 Valves will be discontinued January 2008.
 Do not use for new designs.

UL versions are available on special order.
 For 2 way operation of any 67 Series valve, plug exhaust port 3.
 Consult factory for valves with special mounting configurations, flow requirements or different seal materials.
See miniature solenoid valve accessories for electrical connectors and manifolds. For detail dimensions contact factory.

Miniature Solenoid Valves

Series 79, 81, 84 – 3 or 4 Way

Kuhnke Miniature Valves

Steel Spool Valves, 10/32 (M5) Ported

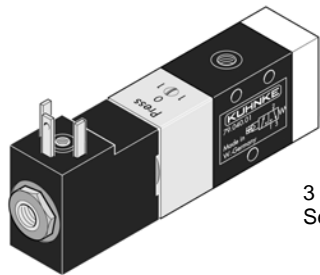

3 Way
Series 79

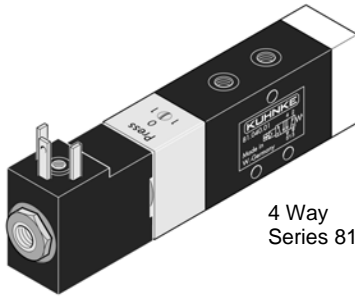

4 Way
Series 81

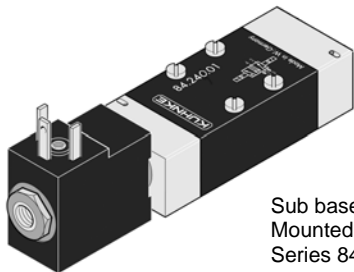

Sub base
Mounted
Series 84

Series 79, 81 and 84 solenoid operated spool valves are constructed of precision lapped steel spools and sleeves. Solenoid coils are encapsulated and have terminals for solder or plug connections. Valves are available for in-line, manifold or sub base mounting.

A characteristic feature of these valves is a hardened and cut steel spool running in a similarly hardened and cut steel liner. The precision fit of these metal elements form the seal. The kinetic energies of the spool when switching over are absorbed by special cushioning in the covers and switching noise is reduced to a minimum.

Types: Standard valves are available for in-line (Series 79,81) or sub base (Series 84) mounting. In-line (body ported) valves are mounted using (3) 1/8" dia. holes through the body. Sub base mounted valves can use a molded or aluminum base. Both in-line or sub base mounted valves can be used with Kuhnke manifolds for built up valve banks.

For replacement purposes, new valves use the 16mm (Series 64) coil while older designs use a 20mm coil (Series 65). Both are currently available.

Valves have a screwdriver operated manual override, as standard, for testing or by-passing the solenoid operator.

Technical Specifications

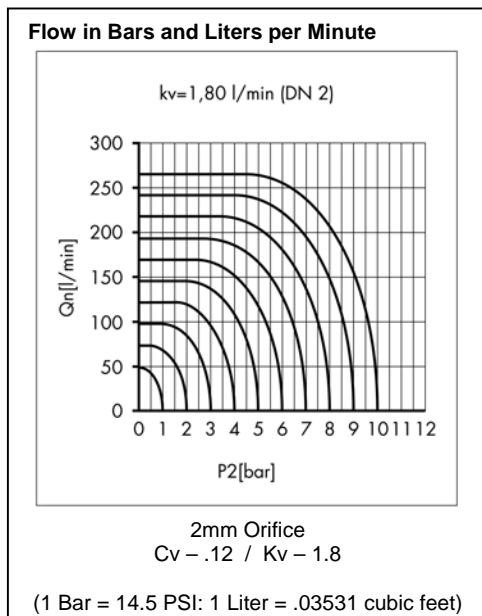

Operating Pressure:

30 to 145 PSI

Vacuum:

Not applicable.

Flow Rate:

7 CFM @ 100 PSI

3 CFM @ 45 PSI

Cv/Kv:

Cv - 0.12

Kv - 1.8

Orifice:

2mm

Connection:

10-32 or M5 ports

Media:

Filtered Air

Coils:

Encapsulated, ground connection standard.

Power Consumption:

DC 1.8W

AC 5 VA

Valve Operating Time:

	AC	DC
Pick-up:	4 ms	10 ms
Drop Out:	3.5 ms	8 ms

Dimensions (inches):

4 Way	Single Solenoid	Double Solenoid
Valve -		
Height:	3 11/16	5 5/16
Width:	5/8	5/8
Depth:	1 1/16	1 1/16
Weight:	6 oz.	9 oz.

Materials:

Aluminum housing, hardened steel spool and sleeve, Buna N seals, encapsulated coil, makrolon end caps.

Average Mechanical Life:

100 million operations

Operating Ambient:

-10°C to 50°C (12°F to 120°F)

Operation:

Air piloted system, supply pressure must be connected to port 1.

Miniature Solenoid Valves

Kuhnke Miniature Valves

Series 79, 81, 84 – 3 or 4 Way

Selection Chart

Valves with Series 64 Coils

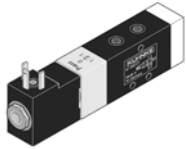

The current design for 10-32 (M5) spool valves includes a Series 64 solenoid system. The coil body is the same size as the valve.

Valves with Series 65 Coils

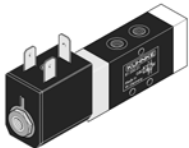

Older valve designs for 10-32 (M5) spool valves include a Series 65 solenoid system. The coil body is wider than the valve. For replacement of existing valves only.

Description	Coil Type	Catalog number	
		In Line Mounted	Manifold Mounted
3 Way Single Solenoid Spring Return 	AC	79040-02-● <i>(79030-02-●)</i>	(Not Available)
	DC	79040-01-● <i>(79030-01-●)</i>	(Not Available)
4 Way Single Solenoid Spring Return 	AC	81040-02-● <i>(81030-02-●)</i>	84240-02-● <i>(84230-02-●)</i>
	DC	81040-01-● <i>(81030-01-●)</i>	84240-01-● <i>(84230-01-●)</i>
4 Way Double Solenoid Detent 	AC	81044-02-● <i>(81034-02-●)</i>	84244-02-● <i>(84234-02-●)</i>
	DC	81044-01-● <i>(81034-01-●)</i>	84244-01-● <i>(84234-01-●)</i>

● - Insert coil voltage required to complete catalog number. Standard voltages are 12 and 24 VDC; 24, 110 and 230 VAC. Catalog numbers in *Italics* are older design valves with 20mm coils. Not recommended for new installations. See explanation, this page.

Sub bases / Manifolds

Manifold kits are available for both in-line or sub base mounted valves. See *accessories*. Single sub bases for mounting series 84 valves are available in 2 versions:

An aluminum sub base, catalog number **84402-01** can be used to individually mount manifold valves. Base dimensions are 2 5/8" L x 1" W x 3/8" H. Tapped holes (M4) at each corner are used for mounting the base. 10-32 (M5) porting is through the bottom.

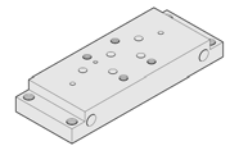

A special molded sub base cat. no. **83450** has instant push in fittings for 5/32 (4mm) tubing and fully adjustable flow controls to provide a compact valve package. Dimensions are 2 3/4" L x 1" W x 3/4" H.

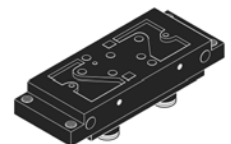

See miniature solenoid valve accessories for manifolds and electrical connectors. For detail dimensions contact factory.

Miniature Solenoid Valves

Series 85, 87 – 3 or 4 Way

Kuhnke Miniature Valves

Steel Spool Valves, 1/8 ports

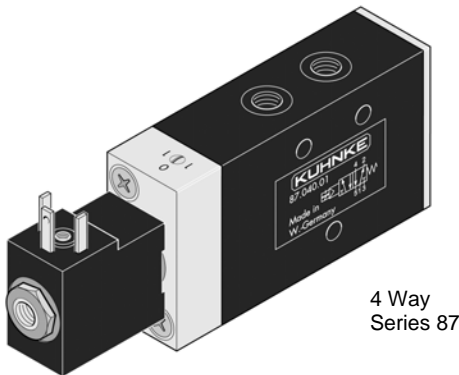
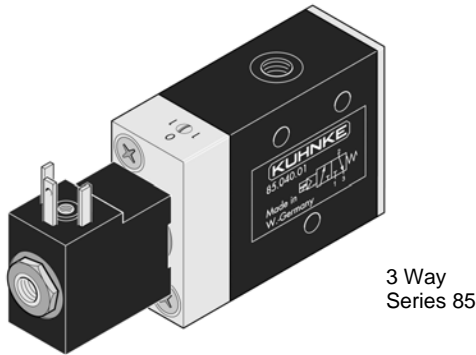

Series 85 and 87 solenoid operated spool valves are constructed of precision lapped steel spools and sleeves. Solenoid coils are encapsulated and have terminals for solder or plug connections. Valves can be mounted in-line or on manifolds.

A characteristic feature of these valves is a hardened and cut steel spool running in a similarly hardened and cut steel liner. The precision fit of these metal elements form the seal. Special cushioning in the covers reduces switching noise to a minimum.

Valves use the standard 16mm (Series 64) coil, in combination with an internal air pilot system, to switch valve position. For replacement purposes, older types with 20 mm coils (Series 65) are available.

All valves are available with a screwdriver manual override for testing, or bypassing the solenoid operator.

Technical Specifications

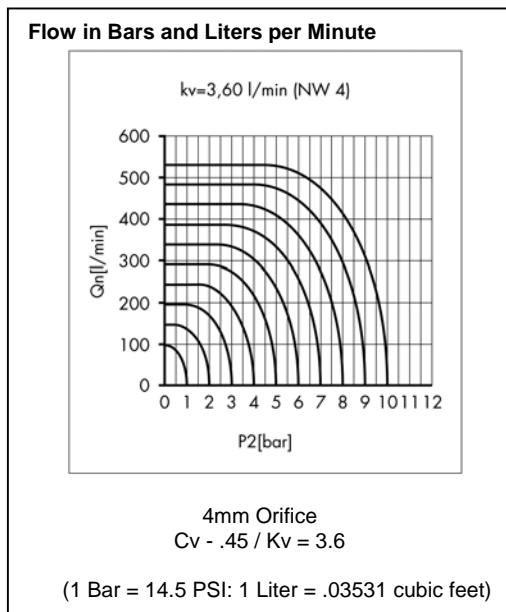

Operating Pressure:

30 to 145 PSI.

Vacuum:

Not applicable.

Flow Rate:

25 CFM @ 100 PSI

10 CFM @ 45 PSI

Cv/Kv:

$Cv - 0.45$

$Kv - 3.6$

Orifice:

4mm

Connection:

1/8 ports

Media:

Filtered Air

Coils:

Encapsulated, ground connection standard.

Power Consumption:

DC - 1.8W

AC - 5 VA

Valve Operating Time:

	AC	DC
Pick-up:	6 ms	12 ms
Drop Out:	7 ms	10 ms

Dimensions (inches):

4 way valve -	Single Solenoid	Double Solenoid
Height:	4 1/8	5 7/8
Width:	3/4	3/4
Depth:	1 3/4	1 3/4
Weight:	10 oz.	15 oz.

Materials:

Aluminum housing, hardened steel spool and sleeve, Buna N seals, encapsulated coil, plated end caps.

Average Mechanical Life:

100 million operations

Operating Ambient:

-10°C to 50°C (12°F to 120°F)

Operation:

Air piloted system, supply pressure must be connected to port 1.

Miniature Solenoid Valves

Kuhnke Miniature Valves

Series 85, 87 – 3 or 4 Way

Selection Chart

Valves with Series 64 Coils

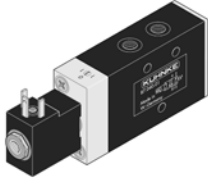

The current design for spool valves includes a Series 64 solenoid system. The coil body is narrower than the valve. Valve ports 1, 3, 5 are offset and when used on manifolds, can be used only on the current design.

Valves with Series 65 Coils

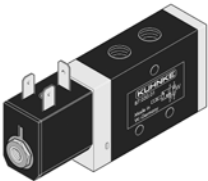

Older valve designs for spool valves include a Series 65 solenoid system. The coil body is the same width as the valve. Ports 1, 3, 5 are in line. For replacement of existing valves only.

Description	Coil Type	Catalog number	
		NPT Ports (USA Std.)	Metric Ports (European Std.)
3 Way Single Solenoid Spring Return 	AC	(Not Available)	85040-02-● <i>(85030-02-●)</i>
	DC	(Not Available)	85040-01-● <i>(85030-01-●)</i>
4 Way Single Solenoid Spring Return 	AC	87140-02-●	87040-02-● <i>(87030-02-●)</i>
	DC	87140-01-●	87040-01-● <i>(87030-01-●)</i>
4 Way Double Solenoid Detent 	AC	87144-02-●	87044-02-● <i>(87037-02-●)</i>
	DC	87144-01-●	87044-01-● <i>(87037-01-●)</i>

● - Insert coil voltage required to complete catalog number. Standard voltages are 12 and 24 VDC; 24, 110 and 230 VAC. Catalog numbers in *Italics* are older design valves with 20mm coils. Not recommended for new installations. See explanation, this page.

Manifolds

Common Input or standard manifold kits are available for constructing valve banks. Common input manifolds accommodate 3 or 4 way valves, while standard manifold kits are designed for 4 way valve assemblies. See *accessories*.

Miniature Solenoid Valves

Series 83 – 4 Way

Kuhnke Miniature Valves

Resilient Seal Spool Valve, Sub Base Mounted

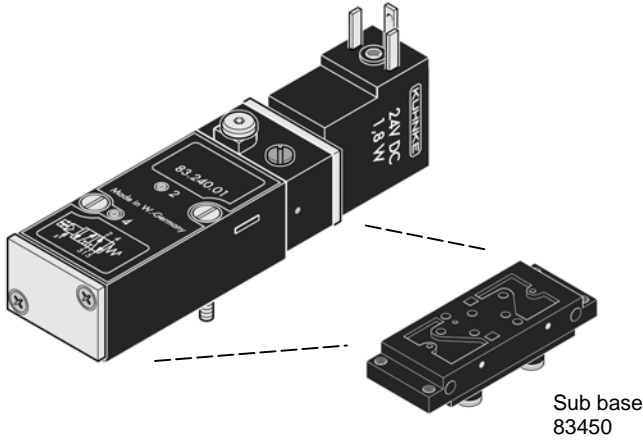

The Series 83 sub base mounted valve provides a simple answer to miniature 4 way valving. The valve is constructed of a molded body and utilizes O-ring construction to provide a lightweight, durable alternative. The valve has red pop-up indicators to show position, as well as a manual override and an external air pilot supply port connection, used when switching pressures less than 35 PSI.

A special molded sub base cat. no. **83450** has instant push in fittings for 5/32 (4mm) tubing and fully adjustable flow controls to provide a compact valve package. The Series 83 valve can also be mounted on a standard aluminum sub plate cat. no. **84402-01** or on standard manifolds for Series 84 valves, see accessories.

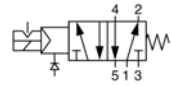
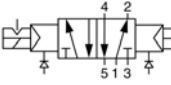
Description	Coil Type	Catalog Number
4 Way Single Solenoid Spring Return 	AC	83240-02-● <i>(83230-02-●)</i>
	DC	83240-01-● <i>(83230-01-●)</i>
4 Way Double Solenoid Detent 	AC	83244-02-● <i>(83234-02-●)</i>
	DC	83244-01-● <i>(83234-01-●)</i>

● - Insert coil voltage required to complete catalog number. Standard voltages are 12 and 24 VDC; 24, 110 and 230 VAC. Catalog numbers in *Italics* are older design valves with 20mm coils. Not recommended for new installations.

Technical Specifications

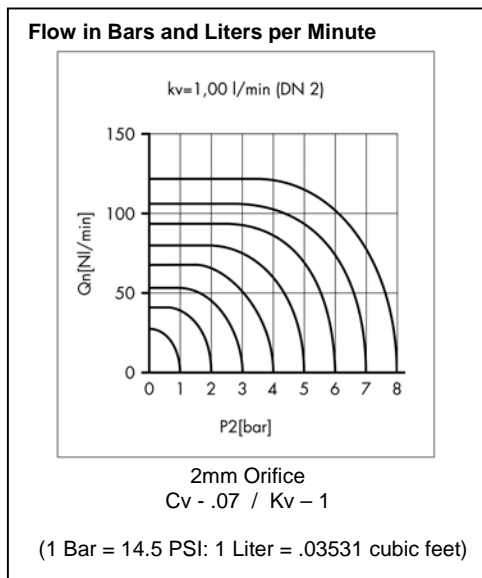

Operating Pressure:
35-115 PSI max.

Vacuum:
Not applicable.

Flow Rate:
5 CFM @ 100 PSI
2 CFM @ 45 PSI

Cv/Kv:
Cv - 0.07
Kv - 1.00

Orifice:
2mm

Connection:
10-32 (M5) ported sub base.

Media:
Filtered Air

Coils:
Encapsulated, ground connection standard.

Power Consumption:
DC: 1.8W / AC 5.5 VA

Valve Operating Time:

	AC	DC
Pick-up	4 ms	10 ms
Drop Out	3.5 ms	8 ms

Dimensions (inches):

	Single Solenoid	Double Solenoid
Height:	3 11/16	5 5/16
Width:	5/8	5/8
Depth:	1 1/16	1 1/16
Weight:	5 1/2 oz	8 oz.

Materials:
Molded body, Buna N Seals, zinc end caps

Average Mechanical Life:
20 million operations

Operating Ambient:
-10°C to 60°C (12°F to 140°F)

Operation:
Air piloted system, supply pressure must be connected to port 1.

Pilot Valves

- N.C. 3 Way (1mm Orifice) **76136-01-00**
- N.O. 3 Way (1mm Orifice) **76136-02-00**
- Single sub base (G1/8 metric ports) **76420-03-01**
- Manifold section (through feed G1/8 metric ports) **76420-03-03**

The 3 way pilot valve section of general purpose solenoid-operated valves can be used as a remote air pilot valve or for switching low volumes of air when mounted on a sub base or manifold. The valve has a flow of approximately 2 CFM at 90 PSI. Operating pressure range is 0-115 PSI. The valve includes a red lever for manual operation. *Select coils separately from the chart below.*

Sub bases and Manifolds

Pilot valves are mounted on a sub base or on a built up modular manifold system, using a base with through feed ports. Manifolds are assembled by fastening the required number of station sections together with the included O ring and screw. To close off the manifold the through port can be plugged or a sub base section can be used as the last station on the assembly. The valve is fastened to the base with 2 included screws. Units can be mounted on a surface using (2) 5/32" through body holes. Dimensions for each sub base or manifold section are 1 5/8" L x 1 1/8" W. With valve mounted, the height is 2 7/8".

Molded Pilot Valve



Base mounted 3 way valves, cat. no. **76036-01-00** (Norm. Closed) or **76036-02-00** (Norm. Open) are also available for surface mounting applications. Units are made of Zamak (a molded plastic) with NBR seals and have G 1/8 metric ports. Orifice size is 1.2mm, operating pressure range is 0-150 PSI with a flow of approximately 2.1 CFM at 115 PSI.

Dimensions are 7/8" W x 1 1/4" D x 2 3/8" H. Can be individually mounted on surfaces via (2) 3/16" holes or from beneath with (2) M5 tapped holes.

Select coils separately from the coil chart.

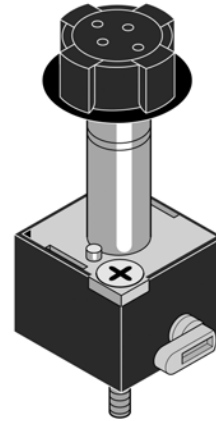
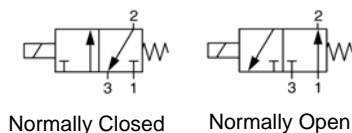

Pilot Valve

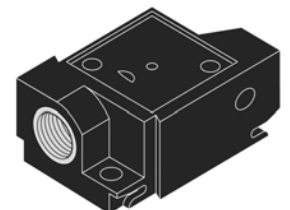

Sub Base

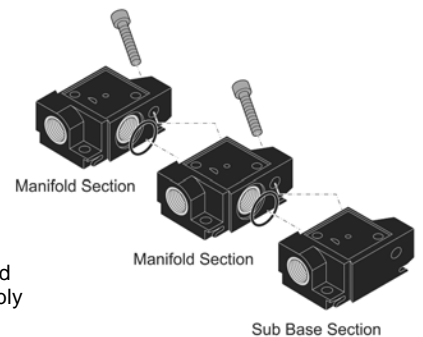

Manifold Assembly

Manifold Section

Manifold Section

Sub Base Section

Order Coils Separately

Valve catalog numbers do not include solenoid coils. Coils are supplied loose and un mounted as separate items.

AC Coil Catalog No. 76410-02-**
DC Coil Catalog No. 76410-00-**

** - Add the required coil voltage suffix code from the chart below to complete the coil catalog number.

Voltage	AC	DC
12V	-	01
24V	12	02
48V	13	03
110V	14	04
230V	15	05

Miniature Solenoid Valves

Accessories

Kuhnke Miniature Valves

Manifold Kits – 2 or 3 Way Manifold Mounted Valves

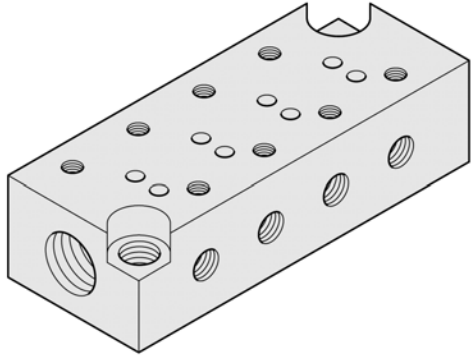

Manifolds are available for all solenoid operated 2 or 3 way valves. Units are constructed of aluminum bar stock with 1/8 metric supply ports at each end and 10-32 (M5) output ports along valve stack for Series 64 and 65 valves. Series 67 valve manifolds have 1/8 metric output ports. Manifolds are all pre-drilled to allow valves to be mounted side by side without intermediate spacing. Standard manifolds are available for single, double or 4 station configurations and can also be special ordered for up to 8 stations. Mounting is via an M5 tapped hole at each end of the manifold.

Manifolds can be butted together using an extension fitting cat. no. 67500 to meet specific station requirements. The extension fitting is a special double nipple that is inserted at the end ports of the adjacent manifolds when units are mounted.



If a valve station on a manifold is unoccupied (for future use), a blanking plate must be used to block manifold ports. Blanking plate kits include a steel plate, O rings and mounting hardware.

All sub base mounted valves are supplied with O rings and screws for mounting on these manifolds.

Valve Series	Dimensions with valves mounted * (W x H x L)	Single Station		Double Station		4 Station	
		Catalog Number	L - Dim	Catalog Number	L - Dim.	Catalog Number	L - Dim.
64	1 3/8 x 2 1/4 x L Dim.	64225-01	1 5/16	64225-02	2	64225-04	3 5/16
65	1 1/2 x 2 3/8 x L Dim.	65280-01	7/8	65280-02	1 7/8	65280-04	3 5/8
67	1 3/4 x 3 1/4 x L Dim.	67200-01	1 5/16	67200-02	2 5/8	67200-04	5 3/16

Manifold Accessories

Manifold extension fitting	67500
64 Series blanking plate kit	64130
65 Series blanking plate kit	65370
67 Series blanking plate kit	67224

* Dimensions include valves, but not electrical connector plugs. If used, add 2 1/2 inches min. clearance to the width dimension.
Manifolds can be ordered with up to 8 stations, contact factory for details.

For detail dimensions contact factory.

Manifold Kits – 10-32 (M5) Ported Spool Valves

Manifold system kits are available for sub base mounted (Series 83/84) or in-line solenoid operated 4-way valves (Series 81).

The manifold system consists of a header kit and manifold base kits (as required) that can be assembled to meet specific applications. The header kit consists of 2 headers, with G1/8 (metric) ports, 2 tie rods, nuts and gaskets. The headers provide supply and exhaust connections to the manifold system.

Manifold bases for in-line or sub base mounted valves are added to meet station requirements. Each manifold base is butt mounted and sealed with O rings. Tie rods inserted through the bases and headers hold the assembly together. The standard tie rod supplied with the header kit can accommodate up to 8 sub base mounted valves. An extra length tie rod is available to provide up to 18 sub base valve positions.

Each manifold station kit is supplied with mounting hardware and O rings. Station kits for sub base mounted valves (Series 83 or 84) accommodate one valve and are bottom ported. In-line valve base kits accommodate up to 6 valves (Series 81) and outgoing connections are made at the top of the valve.

A blanking bar, cat. no. 81111, is required to block off manifold positions of *in-line mounted valves* if a spare position is desired.

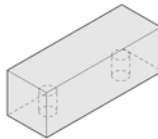

Several other pneumatic devices can also be assembled on this manifold. See regulators, timers, P/E switches and Series 65 valves.

Sub base mounted valves are supplied with mounting hardware and gaskets.

Manifold Accessories

Supply port cap nut	50500
Blanking bar kit (in-line base)	81111
Spare hollow bolt (in-line base)	71-750-026-01-00
Spare washer (in-line base)	50001
Extra length tie rod (2 required)	84221

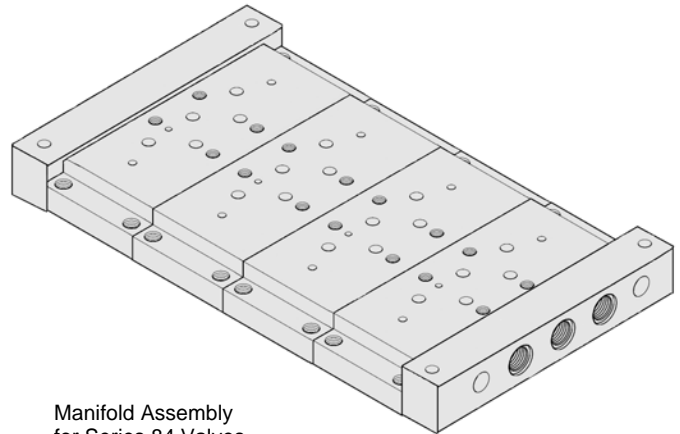

Manifold Assembly for Series 84 Valves

Description	Width Dim.	Catalog Number
Header Kit	9/16" x 2	84465
Base for Sub Base Mtd. Valve (83/84 Series)	1"	84463
Base for 1 In-Line Valve (81 Series)	1 1/16"	81110-01
Base for 2 In-Line Valves (81 Series)	1 11/32"	81110-02
Base for 4 In-Line Valves (81 Series)	2 11/16"	81110-04
Base for 6 In-Line Valves (81 Series)	4"	81110-06

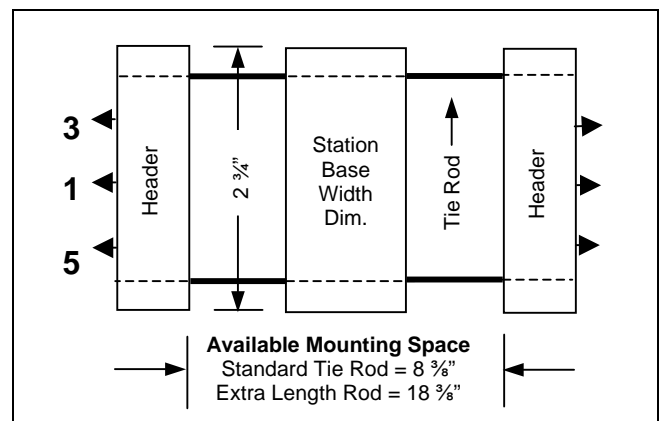

Single sub bases are available for individual mounting of valves, see valve catalog pages.
For detail dimensions contact factory.

Miniature Solenoid Valves

Accessories

Kuhnke Miniature Valves

Manifold Kits – 1/8 Ported Spool Valves

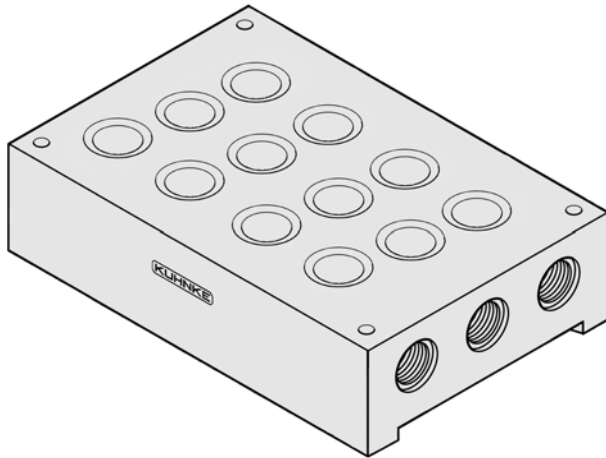

Manifold kits for 1/8 ported Series 87, 4 way valves include a manifold with 1/4 supply ports at each end, and valve mounting hardware. Standard manifolds are available for 2, 3, 4, 6, or 8 station configurations. Manifolds can also be custom made with any number of stations; consult factory for details. These units cannot be used with old design valves using 22mm solenoid coils, see valve catalog page.

Manifolds are single piece aluminum bases with common supply and exhaust ports. Kits include all valve mounting hardware, which accommodates both NPT, or Metric ported versions of valves. Hollow bolts are used to connect the valve to the base from below to supply the line air pressure and to provide a common connection for exhaust ports.

If a valve station on a manifold is unoccupied, a blanking bar (cat. no. 87351) must be used to block manifold ports.

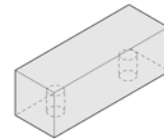

The manifold can be mounted by means of 5/32" holes at each corner of the aluminum base.

Number of Stations	Dimensions H x W x L (inches)	Catalog Number	
		NPT Ports (USA Std.)	Metric Ports (European Std.)
2	7/8 x 2 3/4 x 3 1/8	87360-02	87350-02
3	7/8 x 2 3/4 x 4	(Not Available)	87350-03
4	7/8 x 2 3/4 x 4 7/8	87360-04	87350-04
6	7/8 x 2 3/4 x 6 5/8	87360-06	87350-06
8	7/8 x 2 3/4 x 8 3/8	87360-08	87350-08

Manifold Accessories

Blanking bar kit	87351
Spare hollow bolt	50812
Spare washer for banjo screw	50010
Spare O ring (valve/manifold seal)	560-110-110-015

Manifold kits are designed only for new versions of 87 Series valves, see valve catalog page.

For detail dimensions contact factory.

Common Input Manifold Kits

Common input manifold kits can be used for Series 64 in-line mounted valves, or for all in-line mounted spool valves.

Kits include manifold, valve mounting bolts, washers and O rings or seals. Units are made from aluminum bar stock. All fittings are brass.

Manifolds for 10-32 (M5) ported valves have 10-32 (M5) supply ports at each end. Connections to valve ports are via a special hollow bolt. Unoccupied valve positions require a cap nut cat. no. 50814 to seal off manifold. Manifolds have 1/8" diameter mounting holes, 1/4" from each end. *For dimensions see chart.*

Manifolds for 1/8 ported valves have 1/4 supply ports at each end. Connections to valve ports are via a special hollow bolt. Unoccupied valve positions require a cap nut, cat. no. 50813 to seal off manifold. Manifolds for 1/8" ported valves have (2) 1/8" diameter mounting holes, 13/16" from each end. *For dimensions see chart.*

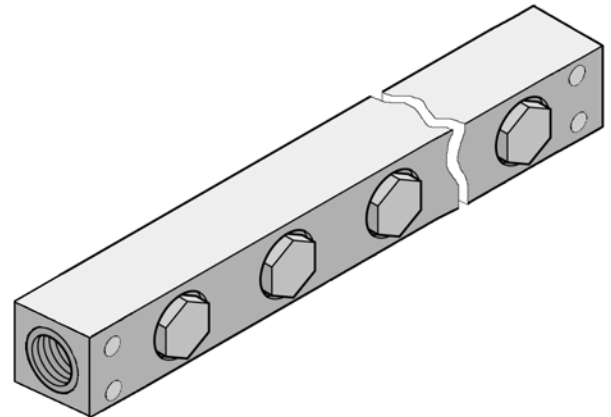

Number of Stations	For 10-32 (M5) Ported Valves		For 1/8 NPT Ported Valves (USA Std.)		For 1/8 Metric Ported Valves (Euro Std.)	
	Dimensions 3/8" W. x 7/16"H x L Dim. Below	Catalog Number	Dimensions 5/8" W. x 3/4"H x L Dim. Below	Catalog Number	Dimensions 5/8" W. x 3/4"H x L Dim. Below	Catalog Number
2	2 1/2"	44404-02	3 5/8"	87355-02	3 5/8"	87452-02
3	--	--	--	--	4 1/8"	87452-03
4	4 5/16"	44404-04	5 7/16"	87355-04	5 7/16"	87452-04
6	6 1/8"	44404-06	7 3/16"	87355-06	7 3/16"	87452-06
8	7 15/16"	44404-08	9	87355-08	9	87452-08
10	9 3/4"	44404-10	--	--	--	--

Manifold Accessories

	Manifold <u>44404</u>	Manifold <u>87355/87452</u>
Cap nut	50814	50813
Supply port cap nut	50500	--
Spare hollow bolt	71-750-026-01-00	50812
Spare O ring (for banjo sc.)	--	560-110-110-015
Spare washer (for banjo sc.)	50001	50010

Miniature Solenoid Valves

Accessories

Kuhnke Miniature Valves

Standard Solenoid Coils

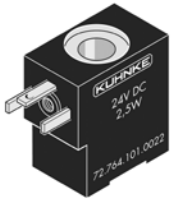

Series 64

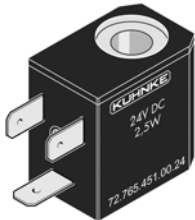

Series 65

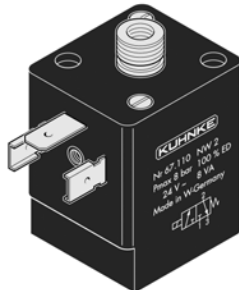

Series 67

Standard replacement coils are available for all types of miniature solenoid valves. Coils are encapsulated to keep out water, oil and other contaminants providing splash proof protection when used with the corresponding socket and gaskets for miniature valves.

Interchanging different voltage coils- Coils for solenoid operators are generally interchangeable within certain limitations. AC valve armature construction includes a shunt operating coil and is required for AC voltage operation; therefore, AC coils are interchangeable only on AC valves. DC coils may be used on valves with AC or DC armatures. Also, low power DC valve designs have specially designed coils and valve armatures; therefore, low power coils should not be used on standard valves.

Pick up and drop out voltage tolerances vary for each type of coil; Series 64 $\pm 10\%$ of rated voltage; Series 65 $+5/-10\%$ of rated voltage and Series 67 - AC: $+10/-20\%$; DC: $+10/-15\%$ of rated voltage.

Description	Series 64 Coil			Series 65 Coil			Series 67 Coil			
	Power Consumption	Resistance (Ohms Ω)	Catalog Number	Power Consumption	Resistance (Ohms Ω)	Catalog Number	Power Consumption	Resistance (Ohms Ω)	Catalog Number	
Standard DC-	12V	386mA	31	JL5910024	350mA	34	JL5910018	460mA	26	JL4900025
	24V	193mA	124	JL5910022	205mA	117	JL5910003	260mA	92	JL4900024
Low Power DC-	12V	129mA	93	JL5910008	129mA	93	JL5910013	130mA	92	JL4900022
	24V	59mA	403	JL5910001	59mA	403	JL5910002	60mA	393	JL4900021
Standard AC-	24V	200mA	57	JL5910004	200mA	57	JL5910006	330mA	17	JL4900019
	110V	32mA	1440	JL5910005	50mA	1036	JL5910015	98mA	393	JL4900018
	230V	22mA	4350	JL5910009	22mA	4950	JL5910007	36mA	1750	JL4900016

Electrical Connectors

Electrical connectors are available in 3 versions: connector plug only, connector plug with prewired 9 foot (3 meter) cable and a connector plug with built in surge suppressor and LED with a prewired 9 foot (3 meter) cable.

Plug in sockets are constructed of a flame resistant, black molded material and include a sealing ring which provides splash proof protection (NEMA 12, IP65).

Series 65 and 67 sockets have screw terminals for a maximum wire size of No. 16 stranded (1.5mm²). Series 64 sockets have screw terminals for No. 18 stranded wire (0.75mm²). Maximum cable jacket size for connector sealing ring is 5/16 inch diameter.

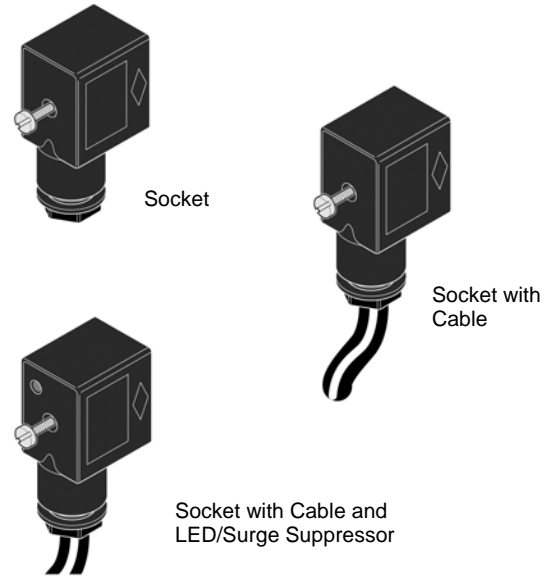

Description	Catalog Number			
	Use on 64 Series Valves	Use on 65 Series Valves	Use on 67 Series Valves	Use on 79, 81, 83, 84, 85, 87 Series**
Socket Only	64230-01	65495-00	67499-00	64230-01
Pre Wired Socket With 9 ft (3 meter) cable	64157-02	65495-01	67499-01	64157-02
Pre Wired Socket With 9 ft (3 meter) cable with built in yellow LED and surge suppressor for 24 VAC or DC Max.	64157-01	65495-02	67499-02	64157-01

** - Some older spool valve designs utilize Series 65 coils, see the valve catalog pages. Use the appropriate sockets for these valves. Standard fully insulated female slip on crimp terminals can also be used for making electrical connections. Series 65 valves use NEMA tab size .032 x .250. Series 67 uses NEMA tab size .032 x .250 on the ground terminal and tab size .032 x .187 on the line terminals.

Miniature Solenoid Valves

Accessories

Kuhnke Miniature Valves

Luminous Seal/Surge Suppressor

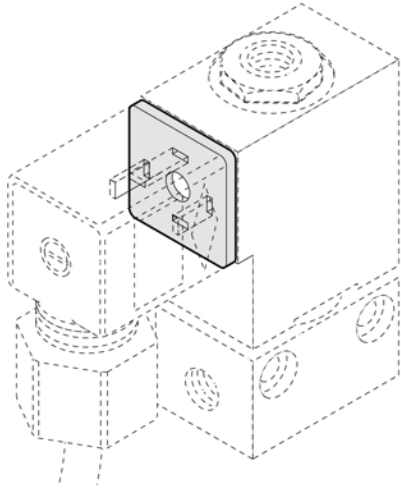

The luminous seal design provides surge suppression, a visual indication of valve on/off state, and forms a seal between coil and socket. Unit has 2 green LED's and a diode bridge, encapsulated in a poly-urethane/silicone material. The seal is approx. 1/8" thick and is sandwiched between coil and socket.

Luminous seals have an operating temperature range of between -12° to 175° F (-25° to 80° C) and consume 0.25 watts at 24VDC.

Coil Voltage (AC or DC)	Catalog Number			
	Use on 64 Series Valves	Use on 65 Series Valves	Use on 67 Series Valves	Use on 79, 81, 83, 84, 85, 87 Series**
12 to 24V	64330	65553	67230	64330
42 to 48 V	64330-01	65553-01	67230-01	64330-01
120V	64330-02	65553-02	67230-02	64330-02
230V	--	65553-03	67230-03	--

** Older designs of spool valves with 20mm coils require seals for Series 65 valves.

Manually, Mechanically and Pneumatically Operated Miniature Valves

Kuhnke manufactures a wide range of miniature valves to suit specific application requirements. Operator types include plungers, roller levers, pushbuttons, joystick, roller ball designs as well as air bleed and air pressure assisted versions. All valves are compact for easy mounting in tight spaces.

Among the valve families are the Series 72 micro valve, made of molded material and approximately the size of an electrical micro switch. These valves use an air bleed system to achieve low actuation forces.

Series 74 general purpose valves are compact units constructed of a zinc alloy housing with a maximum operating pressure of 175 PSI. Valves are less than 1 inch square.

Series 46 Brass valves are a rugged 3 way poppet design machined from a brass hex bar and can be used for normally open, normally closed or diverter functions.

Series 79, 81 and 84 steel spool valves are long life devices, several with internal air piloted systems that yield low operating forces. Unique amplifier and pulse shaping versions are also included for special applications.

A selection of pneumatically operated spool valves is also available in both 10-32 (M5) and 1/8 ports.

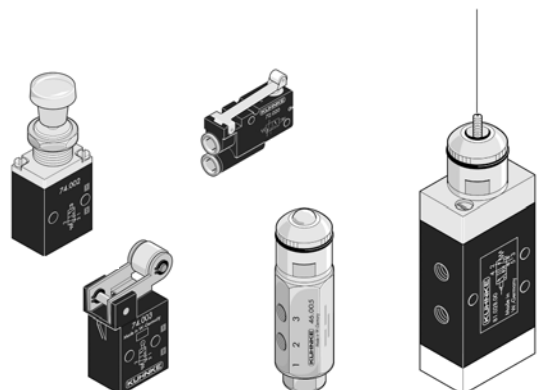

The following page(s) are extracted from multi-page Kuhnke product catalogues or CDRoms and any page number shown is relevant to the original document. The PDF sheets here may have been combined to provide technical information about the specific product(s) you have selected.

Hard copy product catalogues, and CDRoms have been published describing Kuhnke Pneumatics, Solenoids, Relays and Electronics; some divided into different books. A list of current publications is available on this web site or from our sales offices. Some may be available for download, but as substantially larger files.

Contact Details

Kuhnke sales and service in North America

Kuhnke
Automation Inc.
P.O Box 1369
Wayne, N.J.

T: (973) 633 0690
F: (973) 633 7230
Email: sales@kuhnkeusa.com

Important Note

The information shown in these documents is for guidance only. No liability is accepted for any errors or omissions. The designer or user is solely responsible for the safe and proper application of the parts, assemblies or equipment described.

Miniature Valves

Series 72 – 3 Way Micro

Kuhnke Miniature Valves

Mechanically Operated Micro Valves

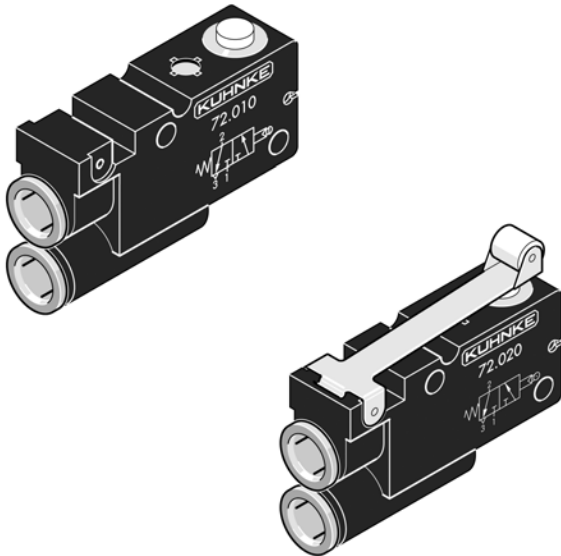

The Series 72 micro air valve was developed as a low cost, reliable signal element for mounting in confined spaces. The valve has an air assisted servo plunger design providing a low actuation force of 3.5 ozs.

Valves are designed to match the dimensions of standard electrical micro switches and have similar actuating forces. Mounting is via through body holes which minimize the need for brackets and allow the valve to be mounted in very tight spaces.

These valves are equipped with instant push in fittings to accommodate flexible 5/32" (4mm) O.D. tubing, eliminating the need for extra fittings. The exhaust port (3) is internal and non accessible.

An air assisted servo controlled pilot consumes approximately .025 CFM and provides an air cushion for the plunger operator. The pilot supply is internally connected to port 1 (air supply) of the valve.

Technical Specifications

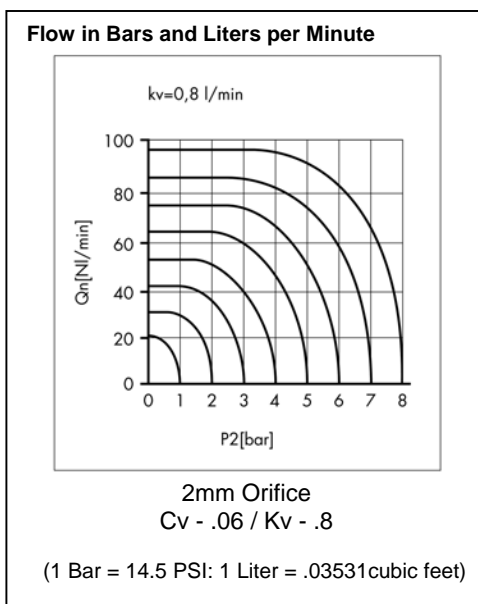

Operating Pressure:

25 to 115 PSI

Vacuum:

Not applicable.

Flow Rate:

2.5 CFM @ 100 PSI

Cv / Kv:

Cv - .06

Kv - .8

Orifice:

2mm

Connection:

Push in fittings for 5/32" (4mm) flexible tubing. Exhaust port 3 is non accessible.

Media:

Filtered air.

Operation:

Air assisted servo controlled element. Supply pressure must be connected to port 1.

Operating time:

65 ms @ 90 PSI

Actuation Force:

3.5 ozs @ 115 PSI.

Actuator Travel:

Approx. 1/32 inch.

Total Travel (override):

3/64 inch.

Air Consumption:

Approx. .025 CFM @ 90 PSI.

Materials:

Polyamide housing, aluminum plunger, Buna N seals, brass fitting inserts.

Average Mechanical Life:

10 million operations

Operating Ambient:

-10°C to 60°C (12°F to 140°F)

Dimensions:

Valve body- 1 3/8" L x 13/32" W x 5/8" H.

Mounting:

(2) 1/8" through body mounting holes.

72010
Norm. Closed
Plunger Operator

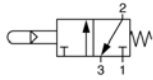

72015
Norm. Open
Plunger Operator

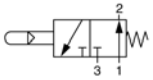

Plunger operated valve can be used as a trigger mechanism on air guns, or to detect end of travel on machinery, tool in position functions, etc. Actuator travel is 3/64" and actuation occurs at 1/32" of travel.

Weight: .125 oz.

72020
Norm. Closed
Roller Lever

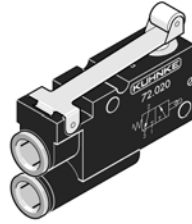
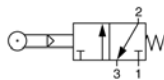

72025
Norm. Open
Roller Lever

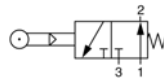

Roller lever allows valve to be mounted in small parts conveyors or moving rail applications. Roller has an override of 3/64". Actuation occurs at 1/32" of travel.

Weight: .25 oz.

72030
Air Jet Detector

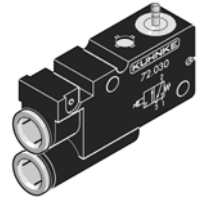
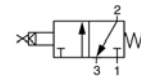

Valve is actuated by remote air jet nozzle, connected to valve via a 5/32" (4mm) O.D. hose equipped with a special nozzle. Air jet is supplied by valve. A stream of air is sent from the nozzle. When an object blocks off the flow of air at the nozzle, the build up of back pressure activates the valve. Any length of hose can be used, however, length of tube (volume) determines valve switch over time. Uses hose kit cat. no. 43138, see accessories.

Weight: .5 oz.

72010
Norm. Closed
Plunger Operator

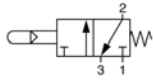

72015
Norm. Open
Plunger Operator

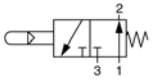

Plunger operated valve can be used as a trigger mechanism on air guns, or to detect end of travel on machinery, tool in position functions, etc. Actuator travel is 3/64" and actuation occurs at 1/32" of travel.

Weight: .125 oz.

72020
Norm. Closed
Roller Lever

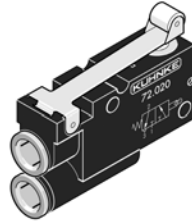
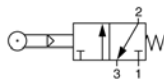

72025
Norm. Open
Roller Lever

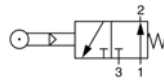

Roller lever allows valve to be mounted in small parts conveyors or moving rail applications. Roller has an override of 3/64". Actuation occurs at 1/32" of travel.

Weight: .25 oz.

72030
Air Jet Detector

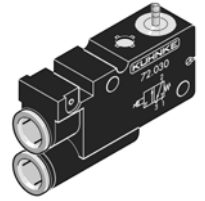
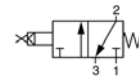

Valve is actuated by remote air jet nozzle, connected to valve via a 5/32" (4mm) O.D. hose equipped with a special nozzle. Air jet is supplied by valve. A stream of air is sent from the nozzle. When an object blocks off the flow of air at the nozzle, the build up of back pressure activates the valve. Any length of hose can be used, however, length of tube (volume) determines valve switch over time. Uses hose kit cat. no. 43138, see accessories.

Weight: .5 oz.

The following page(s) are extracted from multi-page Kuhnke product catalogues or CDRoms and any page number shown is relevant to the original document. The PDF sheets here may have been combined to provide technical information about the specific product(s) you have selected.

Hard copy product catalogues, and CDRoms have been published describing Kuhnke Pneumatics, Solenoids, Relays and Electronics; some divided into different books. A list of current publications is available on this web site or from our sales offices. Some may be available for download, but as substantially larger files.

Contact Details

Kuhnke sales and service in North America

Kuhnke
Automation Inc.
P.O Box 1369
Wayne, N.J.

T: (973) 633 0690
F: (973) 633 7230
Email: sales@kuhnkeusa.com

Important Note

The information shown in these documents is for guidance only. No liability is accepted for any errors or omissions. The designer or user is solely responsible for the safe and proper application of the parts, assemblies or equipment described.

Miniature Valves

Series 74 – 3 Way

Kuhnke Miniature Valves

Modular Poppet Valves, Manually and Mechanically Operated

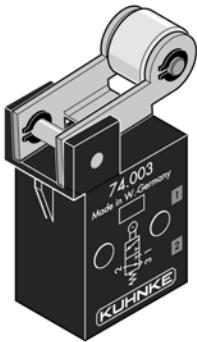
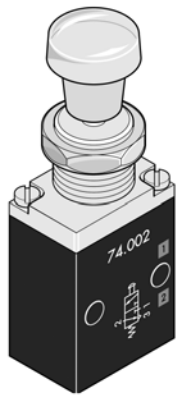
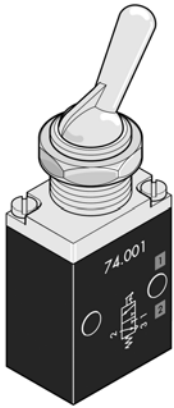

Series 74 valves feature a space saving modular design. Valve bodies take up less than one cubic inch of space and are constructed of a rugged zinc alloy.

Seven types of actuators provide this valve family with wide application possibilities. All designs have low actuation forces and can be applied on systems up to 175 PSI. Valves have a 3 way poppet design, with 10-32 (M5) ports. The exhaust port (3) is internal and non accessible.

All valve bodies can be mounted using (2) 3/16" through body holes; toggle, pushbutton and joystick operators can be panel mounted in a 1/2" diameter hole.

Technical Specifications

Flow in Bars and Liters per Minute

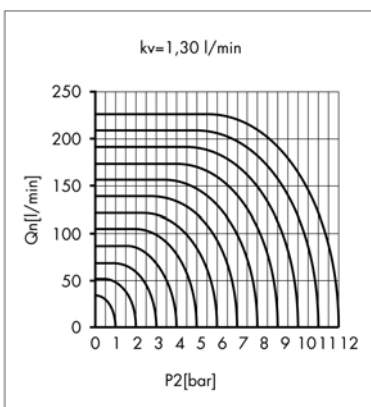

(1 Bar = 14.5 PSI; 1 Liter = .03531 cubic feet)

Operating Pressure:

0 to 175 PSI

Vacuum:

Up to 90%, consult factory with specific application.

Flow Rate:

5.5 CFM @ 100 PSI
2.8 CFM @ 45 PSI

Cv / Kv:

Cv - .1
Kv - 1.3

Orifice:

2mm

Connection:

10-32 or M5 ports. Exhaust port 3 is non accessible.

Media:

Filtered air

Actuation:

Mechanical force required depends on system pressure. (1.75 lbs. @ 90 PSI). Spring assisted return.

Materials:

Zinc alloy housing, buna N seals, brass plunger, polyamide guide.

Average Mechanical Life:

100 million operations

Operating Ambient:

-10°C to 60°C (12°F to 140°F)

Dimensions:

Valve body- 1 3/32" L x 19/32" W x 5/8" H. For operator dimensions see valve description.

Mounting:

Valve body mounting holes (2) 3/16". Panel mounted types mount in a 1/2" diameter hole.

74000 Plunger Operated

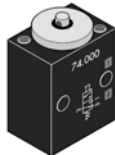
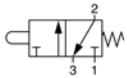

Plunger travel approximately 1/16", spring return. Actuation force at 90 PSI is 5.6 lbs. Used for end of travel applications. Dimension above valve body is 3/16". Weight 1.5 ozs. Can be face mounted via (2) M3 tapped holes.

74003 Roller Lever Operated

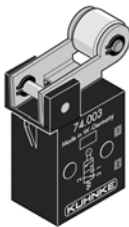
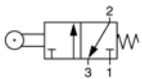

Used as pneumatic limit switch or position detector. Actuator travel 11/64" for valve operation. Actuation force approx. 2 lbs. Weight: 2 ozs. Dimension above valve body is 11/16". Body mount.

74001 Toggle Switch

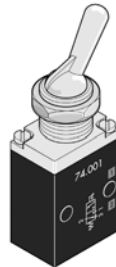
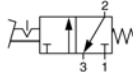

Two position toggle operated. Ideal for switching air supplies on small equipment. Valve can be panel mounted in a 1/2" dia. hole. Weight: 2 ozs. Above panel dimension: 1".

74004 1 Way Roller Lever Operated

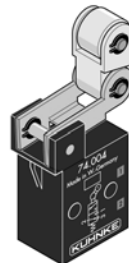
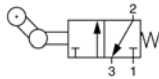

Limit switch operates valve only in one direction. Can be used for limiting travel on machinery. Actuator travels and force, same as 74003. Weight: 2 ozs. Dimension above valve body is 1 3/16". Body mount.

74002 Pushbutton

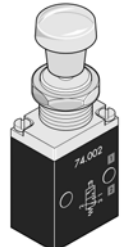
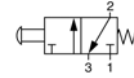

Pushbutton operated, (spring return). Used for momentary air pressure switching. Valve can be panel mounted in a 1/2" dia. hole. Weight 2 ozs. Above panel dimension 1".

74009 Joystick

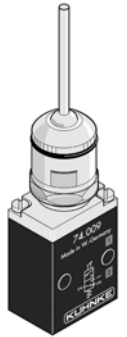
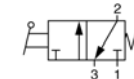

Actuated by moving metal stick in any direction approx. 30°. Spring return to off. Air pilot provides low actuation force of 14.5 ozs. at 90 PSI. Valve can be panel mounted in a 1/2" dia. hole. Weight: 2.5 ozs. Above panel dimension 2 1/8".

74010-03 Valve for Oil-Tight Pushbuttons

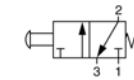

Valve is designed for use with standard miniature size (7/8" dia.) pushbutton operators. Enables pneumatic switching to be combined with electromechanical switching on control consoles. Fits Moeller operators, see accessories. Weight (valve only): 2 .5 ozs.

74000 Plunger Operated

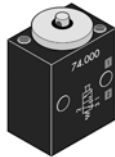
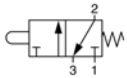

Plunger travel approximately 1/16", spring return. Actuation force at 90 PSI is 5.6 lbs. Used for end of travel applications. Dimension above valve body is 3/16". Weight 1.5 ozs. Can be face mounted via (2) M3 tapped holes.

74003 Roller Lever Operated

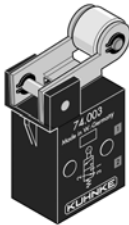
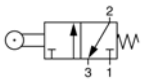

Used as pneumatic limit switch or position detector. Actuator travel 11/64" for valve operation. Actuation force approx. 2 lbs. Weight: 2 ozs. Dimension above valve body is 11/16". Body mount.

74001 Toggle Switch

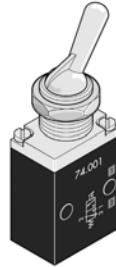
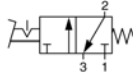

Two position toggle operated. Ideal for switching air supplies on small equipment. Valve can be panel mounted in a 1/2" dia. hole. Weight: 2 ozs. Above panel dimension: 1".

74004 1 Way Roller Lever Operated

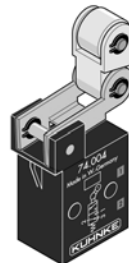
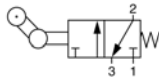

Limit switch operates valve only in one direction. Can be used for limiting travel on machinery. Actuator travels and force, same as 74003. Weight: 2 ozs. Dimension above valve body is 1 3/16". Body mount.

74002 Pushbutton

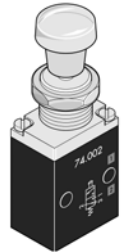
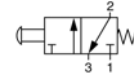

Pushbutton operated, (spring return). Used for momentary air pressure switching. Valve can be panel mounted in a 1/2" dia. hole. Weight 2 ozs. Above panel dimension 1".

74009 Joystick

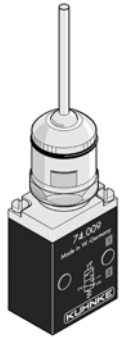
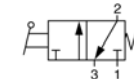

Actuated by moving metal stick in any direction approx. 30°. Spring return to off. Air pilot provides low actuation force of 14.5 ozs. at 90 PSI. Valve can be panel mounted in a 1/2" dia. hole. Weight: 2.5 ozs. Above panel dimension 2 1/8".

74010-03 Valve for Oil-Tight Pushbuttons

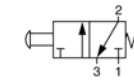

Valve is designed for use with standard miniature size (7/8" dia.) pushbutton operators. Enables pneumatic switching to be combined with electromechanical switching on control consoles. Fits Moeller operators, see accessories. Weight (valve only): 2 .5 ozs.

The following page(s) are extracted from multi-page Kuhnke product catalogues or CDRoms and any page number shown is relevant to the original document. The PDF sheets here may have been combined to provide technical information about the specific product(s) you have selected.

Hard copy product catalogues, and CDRoms have been published describing Kuhnke Pneumatics, Solenoids, Relays and Electronics; some divided into different books. A list of current publications is available on this web site or from our sales offices. Some may be available for download, but as substantially larger files.

Contact Details

Kuhnke sales and service in North America

Kuhnke
Automation Inc.
P.O Box 1369
Wayne, N.J.

T: (973) 633 0690
F: (973) 633 7230
Email: sales@kuhnkeusa.com

Important Note

The information shown in these documents is for guidance only. No liability is accepted for any errors or omissions. The designer or user is solely responsible for the safe and proper application of the parts, assemblies or equipment described.

Miniature Valves

Series 46 - 3 Way Brass

Kuhnke Miniature Valves

Brass Poppet Valves, Manually and Mechanically Operated

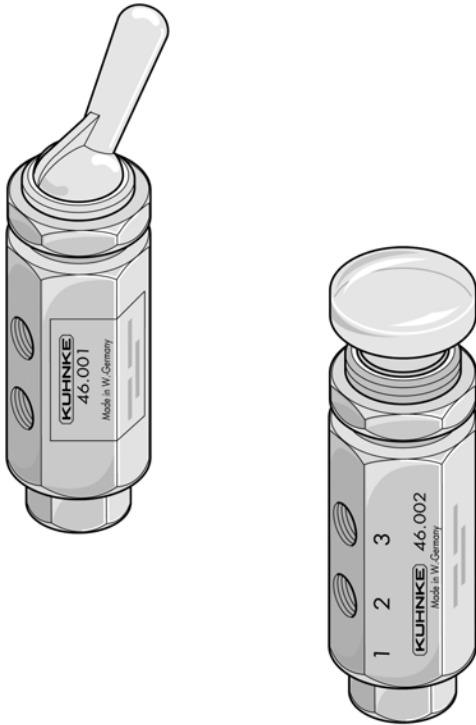

The Series 46 valve is a rugged general purpose 2 or 3 way device. The valve series is available with 7 types of mechanical actuators and 2 types with pneumatic actuation to suit a variety of application requirements.

Series 46 valves can be used for normally closed, normally open or diverter circuits as well as on vacuum or liquid applications.

Constructed from a hex brass bar, valves have 10-32 (M5) ports on its side and rear for easy connections. A nickel chromium plunger and buna N seals provide long life.

Valves can be panel mounted or used with mounting brackets. Standard mounting brackets are available. A hex nut is included for panel or bracket mounting in a 1/2 inch diameter hole.

Technical Specifications

Flow in Bars and Liters per Minute

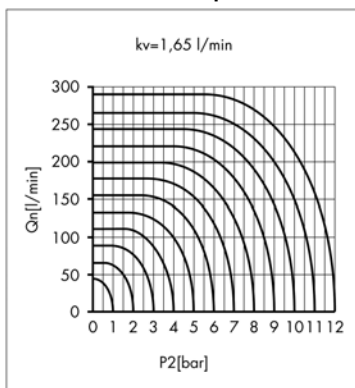

2mm Orifice
Cv - .13 / Kv - 1.65

(1 Bar = 14.5 PSI; 1 Liter = .03531 cubic feet)

Operating Pressure:

0 to 175 PSI

Vacuum:

Up to 90%, consult factory with specific application.

Flow Rate:

7 CFM @ 100 PSI
2.5 CFM @ 45 PSI

Cv / Kv:

Cv - .13
Kv - 1.65

Orifice:

2mm

Connection:

10-32 or M5 ports

Media:

All neutral liquid or gaseous media. (Consult factory before use on liquids.)

Actuation:

Mechanical or pneumatic force required depends on model.
Spring assisted return.

Materials:

Brass housing, buna N seals,
Nickel chromium plunger.

Average Mechanical Life:

100 million operations

Operating Ambient:

-10°C to 70°C (12°F to 160°F)

Dimensions:

Valve body- 1 11/16" L x 9/16" Hex.
For operator dimensions see valve descriptions.

Mounting:

Valve mounts in a 1/2" dia. hole.

46000
Plunger Operated

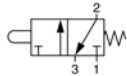

Valve is operated by a plunger. Travel approx. 5/64" for actuation, spring return. Plunger force is dependent on line pressure (force at 90 PSI is 3 lbs.). Ideal for "end of travel" applications. Above panel dimension 13/32". Weight: 1.5 ozs.

46001
Toggle Switch

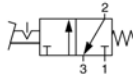

Toggle switch (2 pos.) operated. Ideal for switching air supplies on small equipment. Weight: 2 ozs. Above panel dimension 1".

46002
Pushbutton

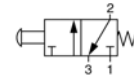

Pushbutton operated, (spring return). Used for momentary air pressure switching. Pushbutton force approx. 3 lbs. @ 90 PSI. Weight 2 ozs. Above panel dimension 9/16".

46003
Roller Lever Operated

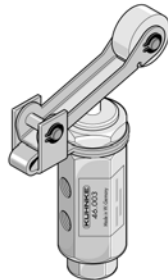
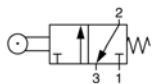

Used as pneumatic limit switch or position detector. Actuator travel 5/32" for valve operation. Actuation force approx. 1.3 lbs. Weight: 5 ozs. Dimension above valve body is 7/8".

46004
1 Way Roller Lever Operated

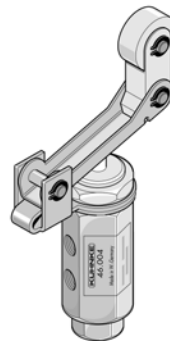
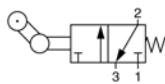

Roller lever operates valve only in one direction. Can be used for limiting travel on machinery. Actuator travels and force, same as 46003. Weight: 5.1 ozs. Dimension above valve body is 1 1/2".

46005
Ball Operator

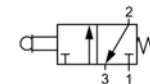

Actuated by pressure on a ball bearing. Travel approx. 5/64" for actuation. Ball bearing rolls with mass as it moves by. Force required (vertical to valve axis) is 3 lbs. at 90 PSI. Can be used for detecting items on conveyors. Weight: 2.6 ozs. Dimension above valve body is 23/32".

46006
Pneumatic Operator
Normally Closed Valve

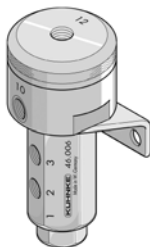

Pneumatically actuated valves can be used for piloting secondary systems. Valves are supplied with mounting bracket. Actuated by applying a pilot pressure between 22 and 85 PSI to the control port. Weight: 5 ozs.

46007
Pneumatic Operator
Normally Open Valve

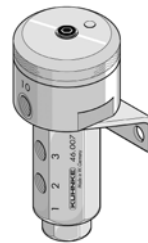
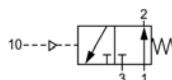

Same as 46006 except equipped with a normally open valve,

46010-03
Valve for Oil-Tight
Pushbuttons

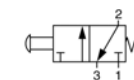

Valve is designed for use with standard miniature size (7/8" dia.) pushbutton operators. Enables pneumatic switching to be combined with electromechanical switching on control consoles. Fits *Moeller* operators, see *accessories*. Weight (valve only): 2.5 ozs.

46000
Plunger Operated

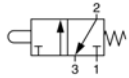

Valve is operated by a plunger. Travel approx. 5/64" for actuation, spring return. Plunger force is dependent on line pressure (force at 90 PSI is 3 lbs.). Ideal for "end of travel" applications. Above panel dimension 13/32". Weight: 1.5 ozs.

46001
Toggle Switch

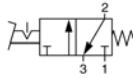

Toggle switch (2 pos.) operated. Ideal for switching air supplies on small equipment. Weight: 2 ozs. Above panel dimension 1".

46002
Pushbutton

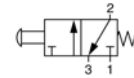

Pushbutton operated, (spring return). Used for momentary air pressure switching. Pushbutton force approx. 3 lbs. @ 90 PSI. Weight 2 ozs. Above panel dimension 9/16".

46003
Roller Lever Operated

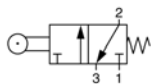

Used as pneumatic limit switch or position detector. Actuator travel 5/32" for valve operation. Actuation force approx. 1.3 lbs. Weight: 5 ozs. Dimension above valve body is 7/8".

46004
1 Way Roller Lever Operated

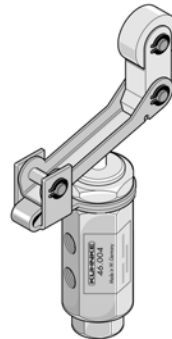
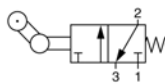

Roller lever operates valve only in one direction. Can be used for limiting travel on machinery. Actuator travels and force, same as 46003. Weight: 5.1 ozs. Dimension above valve body is 1 1/2".

46005
Ball Operator

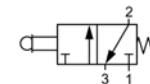

Actuated by pressure on a ball bearing. Travel approx. 5/64" for actuation. Ball bearing rolls with mass as it moves by. Force required (vertical to valve axis) is 3 lbs. at 90 PSI. Can be used for detecting items on conveyors. Weight: 2.6 ozs. Dimension above valve body is 23/32".

46006
Pneumatic Operator
Normally Closed Valve

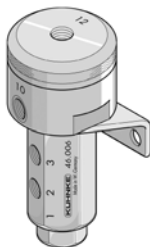
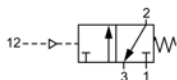

Pneumatically actuated valves can be used for piloting secondary systems. Valves are supplied with mounting bracket. Actuated by applying a pilot pressure between 22 and 85 PSI to the control port. Weight: 5 ozs.

46007
Pneumatic Operator
Normally Open Valve

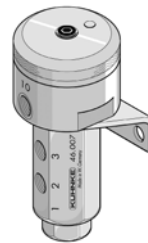
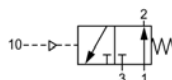

Same as 46006 except equipped with a normally open valve,

46010-03
Valve for Oil-Tight
Pushbuttons

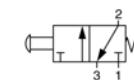

Valve is designed for use with standard miniature size (7/8" dia.) pushbutton operators. Enables pneumatic switching to be combined with electromechanical switching on control consoles. Fits *Moeller* operators, see *accessories*. Weight (valve only): 2.5 ozs.

The following page(s) are extracted from multi-page Kuhnke product catalogues or CDRoms and any page number shown is relevant to the original document. The PDF sheets here may have been combined to provide technical information about the specific product(s) you have selected.

Hard copy product catalogues, and CDRoms have been published describing Kuhnke Pneumatics, Solenoids, Relays and Electronics; some divided into different books. A list of current publications is available on this web site or from our sales offices. Some may be available for download, but as substantially larger files.

Contact Details

Kuhnke sales and service in North America

Kuhnke
Automation Inc.
P.O Box 1369
Wayne, N.J.

T: (973) 633 0690
F: (973) 633 7230
Email: sales@kuhnkeusa.com

Important Note

The information shown in these documents is for guidance only. No liability is accepted for any errors or omissions. The designer or user is solely responsible for the safe and proper application of the parts, assemblies or equipment described.

Miniature Valves

Series 79, 81, 84 Spool Valves

Kuhnke Miniature Valves

Steel Spool Valves, Mechanically and Manually Operated

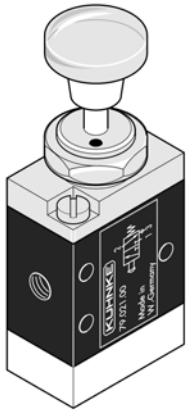

3 Way PB
Series 79

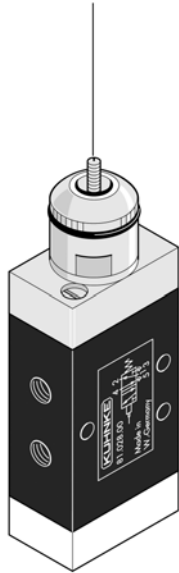

Series 81
Cat
Whisker

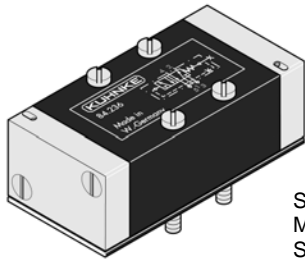

Sub base
Mounted
Series 84

Series 79, 81 and 84 mechanically operated spool valves are constructed of precision lapped steel spools and sleeves. Series 79 is a 3 way valve; Series 81 is a 4 way (5 ported) valve, and Series 84 is a manifold mounted 4 way valve. These valves are fitted with a wide variety of operators including pushbuttons, lever operators, cat whiskers, ball and plungers, in addition to several special application types.

Several valve designs use an air piloted assist mechanism to allow for very low actuation forces.

All valves can be mounted via through body holes, and most valves can be nose mounted (through panel) or on accessory brackets.

Technical Specifications

Flow in Bars and Liters per Minute

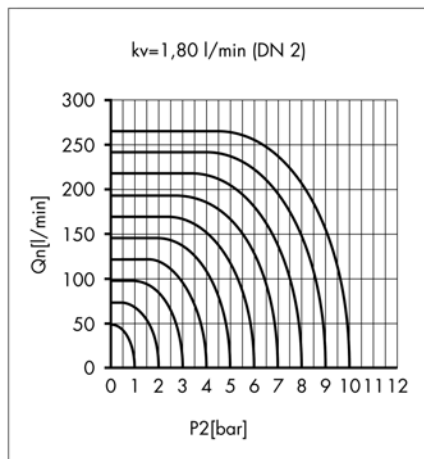

(1 Bar = 14.5 PSI; 1 Liter = .03531 cubic feet)

Operating Pressure:

0 to 145 PSI
Air assist types:
30 to 145 PSI

Vacuum:

Not applicable.

Flow Rate:

7 CFM @ 100 PSI
3 CFM @ 45 PSI

Cv/Kv:

Cv - 0.12
Kv - 1.8

Orifice:

2mm

Connection:

10-32 or M5 ports

Media:

Filtered Air

Actuation:

Force depends on
model. Spring return

Materials:

Aluminum housing, hardened steel
spool and sleeve, Buna N seals,
makrolon or zinc end caps.

Average Mechanical Life:

100 million operations

Operating Ambient:

-10° C to 70° C (12° F to 160° F)

Operation:

For air piloted assist versions,
supply pressure must be
connected to port 1.

Dimensions - Valve Body (inches) :

	3 Way Valve	4 Way Valve
Height:	1 1/2	2
Width:	5/8	5/8
Depth:	1	1

Mounting:

(3) 1/8" through body holes or nose
mounted. See individual valve types.

79020
Plunger Operated
3 Way

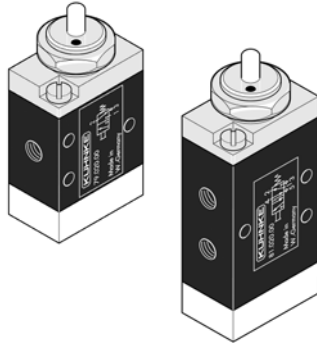
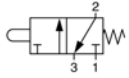

81020
Plunger Operated
4 Way

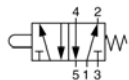

Valve is operated by pressure on plunger. Travel approx. 1/8" for actuation, spring return. Plunger dia. is 3/16", force required – 1 3/4 lbs. Used as end of travel detector or door closed button. Can be panel or bracket mounted in 1/2" dia. hole. Dimension above valve body is 17/32". Weight 2.3 ozs.

79022
Roller Lever
3 Way

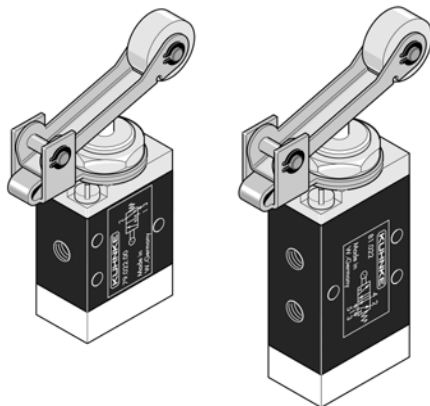
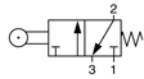

81022
Roller Lever
4 Way

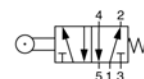

Used as a pneumatic limit switch or position detector. Actuator travel 3/8" for valve operation. Actuation force approx. 14 ozs. Can be bracket mounted in 1/2" dia. hole. Dimension above valve body is 1 3/16". Max. lever travel is 1/2". Weight 2.7 ozs.

79021
Pushbutton
3 Way

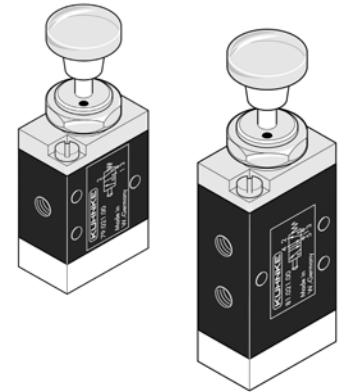
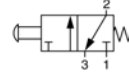

81021
Pushbutton
4 Way

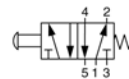

Valve is operated by a small pushbutton. Travel approx. 1/8" for actuation. Momentary (spring return) action. Pushbutton dia. 5/8", force 1 3/4 lbs. Good for general purpose momentary air pressure switching. Can be panel mounted in 1/2" dia. hole. Dimension above valve body is 7/8". Weight 2.4 ozs.

79023
One Way
Roller Lever
3 Way

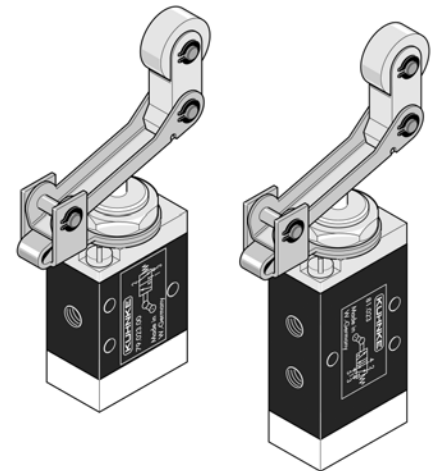
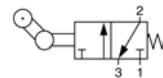

81023
One Way
Roller Lever
4 Way

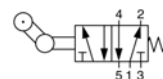

Roller lever operates valve only in one direction. Can be used as safety valve for limiting travel on machinery. Actuator travel and force same as roller lever (opposite). Dim. above valve body is 1 13/16". Max. lever travel is 1/2". In non actuate position roller moves down 5/16". Can be bracket mounted in 1/2" dia. hole. Weight 2.9 ozs.

Miniature Valves

Series 79, 81, 84 Spool Valves

Kuhnke Miniature Valves

79027
Plunger
Air Pilot Assist
3 Way

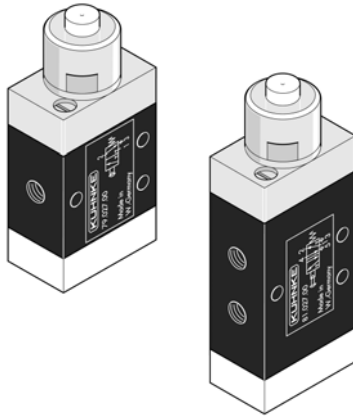
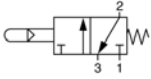

81027
Plunger
Air Pilot Assist
4 Way

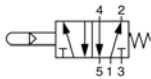

Valve is actuated by light pressure on plunger. Travel less than 1/16" for actuation. Ideal for detecting small parts. Air consumption - .07 CFM, switching time - 65 ms (at 90 PSI). Actuation force is 0.9 oz. Dimension above valve body is 19/32". Weight 2.2 ozs.

79029
Ball Operator
Air Pilot Assist
3 Way

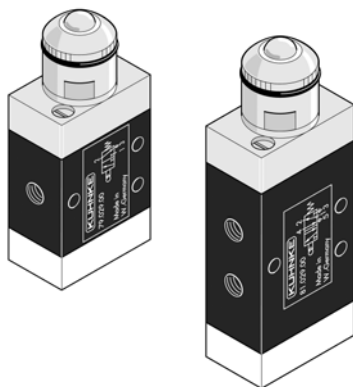
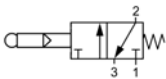

81029
Ball Operator
Air Pilot Assist
4 Way

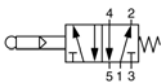

Valve is actuated by pressure on ball bearing. Travel approx. 3/64" for actuation. Ball rolls with mass as it moves by. Force required to actuate valve is 0.9 oz. Can be used for detecting items on conveyor systems. Air consumption - .07 CFM, switching time - 65 ms (at 90 PSI). Dimension above valve body is 3/4". Weight 2.4 ozs.

79028
Cat Whisker
Air Pilot Assist
3 Way

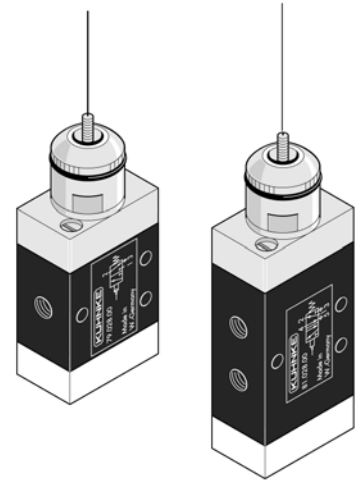
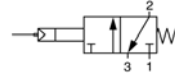

81028
Cat Whisker
Air Pilot Assist
4 Way

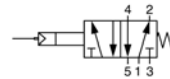

Actuation caused by deflection of fine spring supported wire. Allows valve to be mounted close to detected unit and provides wiping action. Wire can be bent at top up to 3/8" for specific application. Air consumption - .07 CFM, switching time - 65 ms (at 90 PSI). Actuation force is .02 oz. Dimension above valve body is 2 11/16". Weight 2.4 ozs

79017-03
Valve for Oil-Tight
Pushbuttons
3 Way

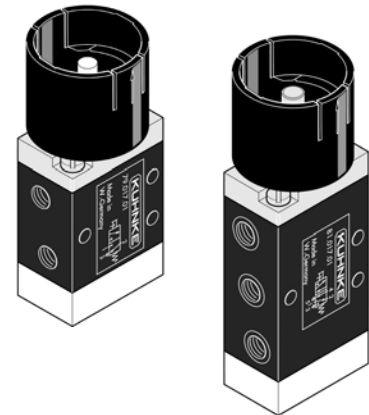
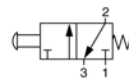

81017-03
Valve for Oil-Tight
Pushbuttons
4 Way

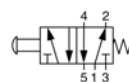

Valve is designed for use with standard miniature size (7/8" dia.) pushbutton operators. Enables pneumatic switching to be combined with electromechanical switching on control consoles. Fits *Moeller* operators, see accessories. Weight (valve only): 2 .5 ozs.

Approximate valve body dimensions are 1.5" L (3 way), 2" L (4 way) x 1" H x 5/8" W. Through body mounting holes (3) are 1/8" dia.
See accessories for brackets and renewal parts. For detail dimensions contact factory.

79024
Amplifier
3 Way

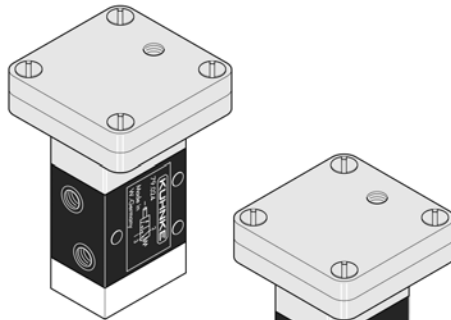
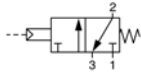

81024
84215 (Manifold Mtd.)
Amplifier
4 Way

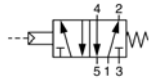

Amplifiers can be used to switch line pressure valves from a low pilot pressure signal. A pressure signal applied to the control port operates valve. Pilot signal range - .075 - 1.5 PSI (5 - 100 mbar). Valve operating pressure - 30 to 115 PSI. Weight 3.1 ozs.

79036
Pulse Shaper
3 Way

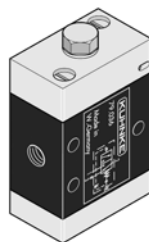
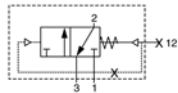

84236 (Manifold Mtd.)
Pulse Shaper
4 Way

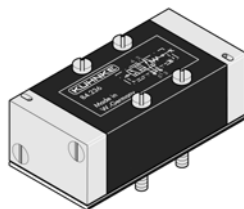
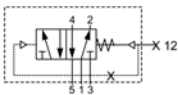

The pulse shaper converts a continuous signal into a pulse signal. Ideal for providing count pulses to pneumatic counters or electronic pressure transducers. Can be applied in parallel with working device circuits that have a long on cycle. Operating pressure range is 45 -145 PSI. Duration of pulse - 80-140 Ms @ 115 PSI.

79026
Air Jet Detector
Fixed Nozzle
3 Way

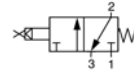

81026
Air Jet Detector
Fixed Nozzle
4 Way

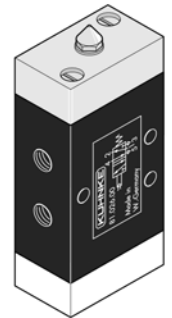
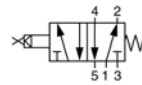

Air jet detectors are used for contact sensing of parts and tools. Can be used with delicate components. A stream of air is sent from a nozzle. As an object touches off the nozzle, the stream is blocked causing back pressure and operating the valve. Air consumption - .07 CFM @ 90 PSI. Switching time @ 90 PSI - 65 ms. Weight 2.1 ozs.

79025
Air Jet Detector
Flexible Nozzle
3 Way

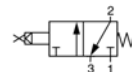

81025
Air Jet Detector
Flexible Nozzle
4 Way

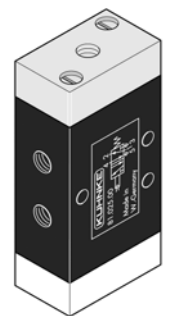
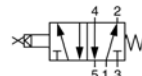

Same as air jet detector above, except used with flexible hose and nozzle. Any length of hose can be used, however, length of tube (volume) determines valve switch over time. Can be used for detecting objects in tight areas. See accessories for hose kit cat. no. 43138. Weight 2 ozs.

For manifolds and sub bases used with valves 84215 or 84236 see accessories for miniature solenoid valves. Approximate valve body dimensions are 1.5" L (3 way), 2" L (4 way) x 1" H x 5/8" W. Through body mounting holes (3) are 1/8" dia. **See accessories for brackets and renewal parts. For detail dimensions contact factory.**

79020
Plunger Operated
3 Way

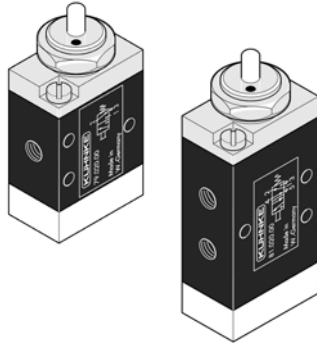
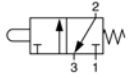

81020
Plunger Operated
4 Way

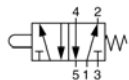

Valve is operated by pressure on plunger. Travel approx. 1/8" for actuation, spring return. Plunger dia. is 3/16", force required – 1 3/4 lbs. Used as end of travel detector or door closed button. Can be panel or bracket mounted in 1/2" dia. hole. Dimension above valve body is 17/32". Weight 2.3 ozs.

79022
Roller Lever
3 Way

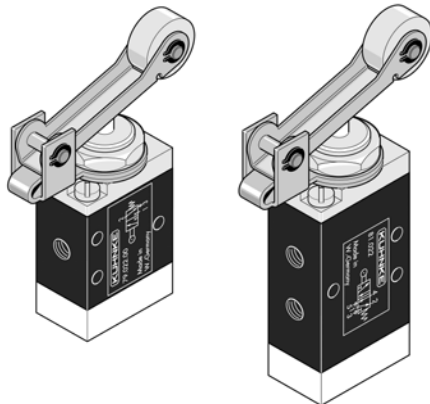
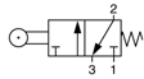

81022
Roller Lever
4 Way

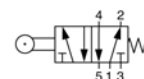

Used as a pneumatic limit switch or position detector. Actuator travel 3/8" for valve operation. Actuation force approx. 14 ozs. Can be bracket mounted in 1/2" dia. hole. Dimension above valve body is 1 3/16". Max. lever travel is 1/2". Weight 2.7 ozs.

79021
Pushbutton
3 Way

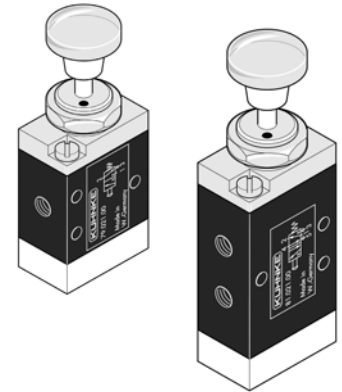
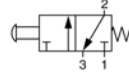

81021
Pushbutton
4 Way

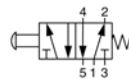

Valve is operated by a small pushbutton. Travel approx. 1/8" for actuation. Momentary (spring return) action. Pushbutton dia. 5/8", force 1 3/4 lbs. Good for general purpose momentary air pressure switching. Can be panel mounted in 1/2" dia. hole. Dimension above valve body is 7/8". Weight 2.4 ozs.

79023
One Way
Roller Lever
3 Way

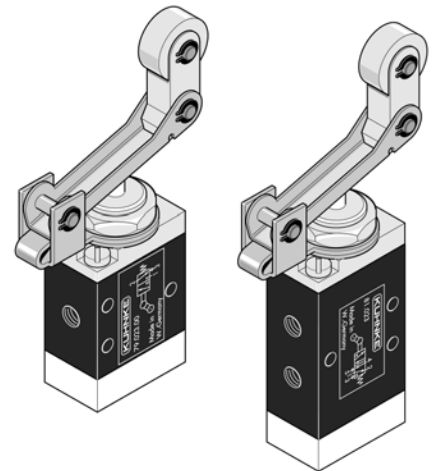
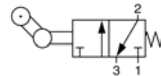

81023
One Way
Roller Lever
4 Way

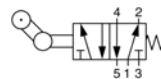

Roller lever operates valve only in one direction. Can be used as safety valve for limiting travel on machinery. Actuator travel and force same as roller lever (opposite). Dim. above valve body is 1 13/16". Max. lever travel is 1/2". In non actuate position roller moves down 5/16". Can be bracket mounted in 1/2" dia. hole. Weight 2.9 ozs.

Miniature Valves

Series 79, 81, 84 Spool Valves

Kuhnke Miniature Valves

79027
Plunger
Air Pilot Assist
3 Way

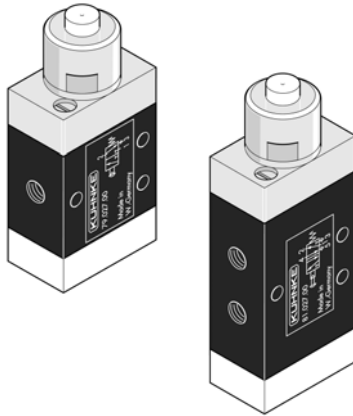
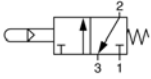

81027
Plunger
Air Pilot Assist
4 Way

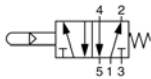

Valve is actuated by light pressure on plunger. Travel less than 1/16" for actuation. Ideal for detecting small parts. Air consumption - .07 CFM, switching time - 65 ms (at 90 PSI). Actuation force is 0.9 oz. Dimension above valve body is 19/32". Weight 2.2 ozs.

79029
Ball Operator
Air Pilot Assist
3 Way

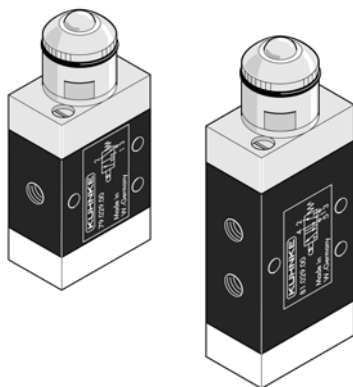
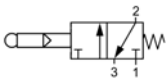

81029
Ball Operator
Air Pilot Assist
4 Way

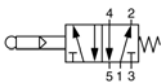

Valve is actuated by pressure on ball bearing. Travel approx. 3/64" for actuation. Ball rolls with mass as it moves by. Force required to actuate valve is 0.9 oz. Can be used for detecting items on conveyor systems. Air consumption - .07 CFM, switching time - 65 ms (at 90 PSI). Dimension above valve body is 3/4". Weight 2.4 ozs.

79028
Cat Whisker
Air Pilot Assist
3 Way

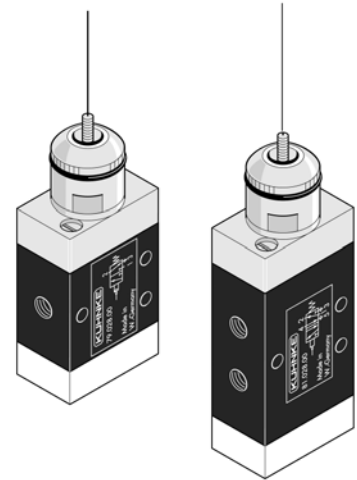
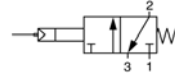

81028
Cat Whisker
Air Pilot Assist
4 Way

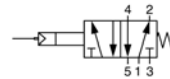

Actuation caused by deflection of fine spring supported wire. Allows valve to be mounted close to detected unit and provides wiping action. Wire can be bent at top up to 3/8" for specific application. Air consumption - .07 CFM, switching time - 65 ms (at 90 PSI). Actuation force is .02 oz. Dimension above valve body is 2 11/16". Weight 2.4 ozs

79017-03
Valve for Oil-Tight
Pushbuttons
3 Way

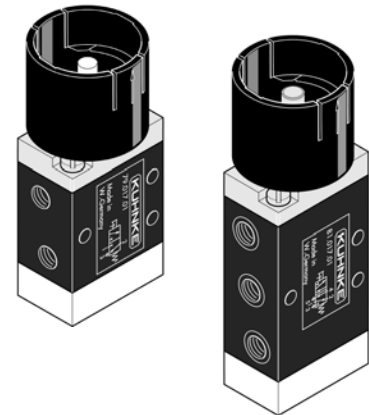
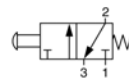

81017-03
Valve for Oil-Tight
Pushbuttons
4 Way

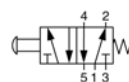

Valve is designed for use with standard miniature size (7/8" dia.) pushbutton operators. Enables pneumatic switching to be combined with electromechanical switching on control consoles. Fits *Moeller* operators, see accessories. Weight (valve only): 2 .5 ozs.

Approximate valve body dimensions are 1.5" L (3 way), 2" L (4 way) x 1" H x 5/8" W. Through body mounting holes (3) are 1/8" dia.
See accessories for brackets and renewal parts. For detail dimensions contact factory.

79024
Amplifier
3 Way

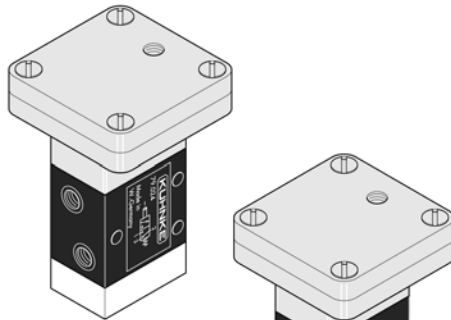
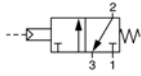

81024
84215 (Manifold Mtd.)
Amplifier
4 Way

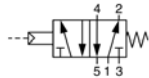

Amplifiers can be used to switch line pressure valves from a low pilot pressure signal. A pressure signal applied to the control port operates valve. Pilot signal range - .075 - 1.5 PSI (5 - 100 mbar). Valve operating pressure - 30 to 115 PSI. Weight 3.1 ozs.

79036
Pulse Shaper
3 Way

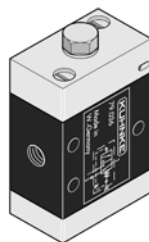
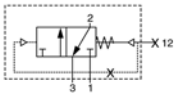

84236 (Manifold Mtd.)
Pulse Shaper
4 Way

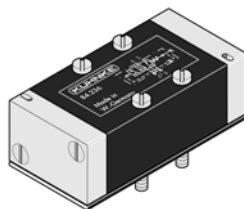
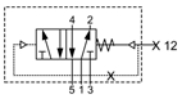

The pulse shaper converts a continuous signal into a pulse signal. Ideal for providing count pulses to pneumatic counters or electronic pressure transducers. Can be applied in parallel with working device circuits that have a long on cycle. Operating pressure range is 45 -145 PSI. Duration of pulse - 80-140 Ms @ 115 PSI.

79026
Air Jet Detector
Fixed Nozzle
3 Way

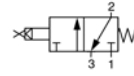

81026
Air Jet Detector
Fixed Nozzle
4 Way

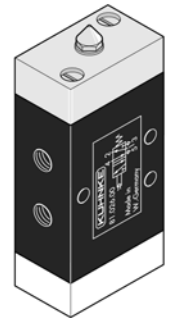
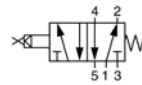

Air jet detectors are used for contact sensing of parts and tools. Can be used with delicate components. A stream of air is sent from a nozzle. As an object touches off the nozzle, the stream is blocked causing back pressure and operating the valve. Air consumption - .07 CFM @ 90 PSI. Switching time @ 90 PSI - 65 ms. Weight 2.1 ozs.

79025
Air Jet Detector
Flexible Nozzle
3 Way

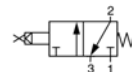

81025
Air Jet Detector
Flexible Nozzle
4 Way

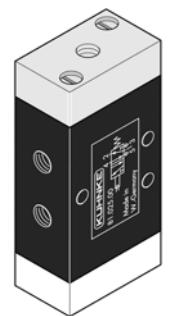
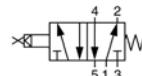

Same as air jet detector above, except used with flexible hose and nozzle. Any length of hose can be used, however, length of tube (volume) determines valve switch over time. Can be used for detecting objects in tight areas. See accessories for hose kit cat. no. 43138. Weight 2 ozs.

For manifolds and sub bases used with valves 84215 or 84236 see accessories for miniature solenoid valves. Approximate valve body dimensions are 1.5" L (3 way), 2" L (4 way) x 1" H x 5/8" W. Through body mounting holes (3) are 1/8" dia. **See accessories for brackets and renewal parts. For detail dimensions contact factory.**

The following page(s) are extracted from multi-page Kuhnke product catalogues or CDRoms and any page number shown is relevant to the original document. The PDF sheets here may have been combined to provide technical information about the specific product(s) you have selected.

Hard copy product catalogues, and CDRoms have been published describing Kuhnke Pneumatics, Solenoids, Relays and Electronics; some divided into different books. A list of current publications is available on this web site or from our sales offices. Some may be available for download, but as substantially larger files.

Contact Details

Kuhnke sales and service in North America

Kuhnke
Automation Inc.
P.O Box 1369
Wayne, N.J.

T: (973) 633 0690
F: (973) 633 7230
Email: sales@kuhnkeusa.com

Important Note

The information shown in these documents is for guidance only. No liability is accepted for any errors or omissions. The designer or user is solely responsible for the safe and proper application of the parts, assemblies or equipment described.

Miniature Valves

Series 79, 81, 84 Spool Valves

Kuhnke Miniature Valves

Steel Spool Valves, Pneumatically Operated, 10/32 (M5) Ported

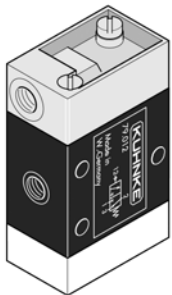

3 Way
Series 79



4 Way
Series 81

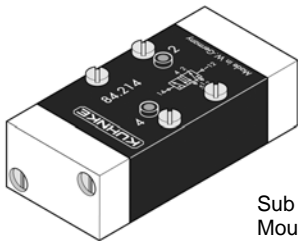

Sub base
Mounted
Series 84

Series 79, 81 and 84 pneumatically operated spool valves are constructed of precision lapped steel spools and sleeves. Valves are available for in-line, manifold or sub base mounting.

A characteristic feature of these valves is a hardened and cut steel spool running in a similarly hardened and cut steel liner. The precision fit of these metal elements form the seal. The kinetic energies of the spool when switching over are absorbed by special cushioning in the covers and switching noise is reduced to a minimum.

This valve series contains a differential pressure valve which can be used for maintaining pressure in air systems. Valve has normal single air pilot spring return function, but with an additional port which can be used to return valve to normal position when secondary pressure reaches supply pressure.

Types: Standard valves are available in 2 mounting configurations, either sub base or in line. In-line (body ported) valves are mounted using (3) 1/8" dia. holes through the body. In-line or sub base mounted valves can be used with Kuhnke accessories or can be mounted on custom manifolds or equipment.

Technical Specifications

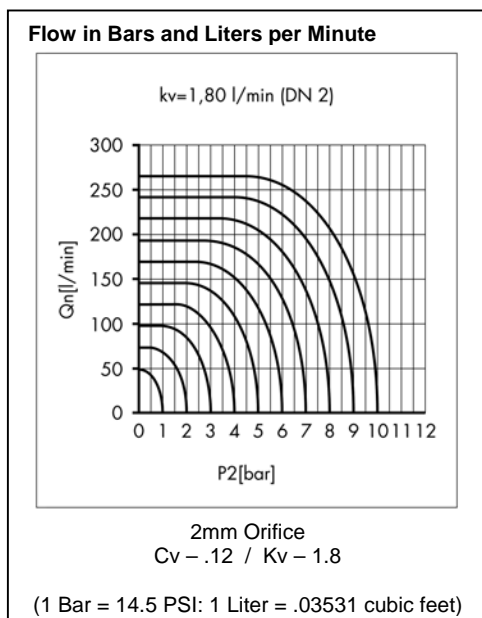

Operating Pressure:

145 PSI Max.
Min. - see actuation force.

Vacuum:

Not applicable.

Flow Rate:

7 CFM @ 100 PSI
3 CFM @ 45 PSI

Cv/Kv:

Cv - 0.12
Kv - 1.8

Orifice:

2mm

Connection:

10-32 or M5 ports

Media:

Filtered Air

Materials:

Aluminum housing, hardened steel spool and sleeve, Buna N seals, makrolon end caps.

Average Mechanical Life:

100 million operations

Operating Ambient:

-10°C to 70°C (12°F to 160°F)

Operation:

Via pneumatic input signal.

Actuation Force:

Min. with spring return- 30 PSI.
Min. with double pilot- 20 PSI.

Dimensions (inches):

	<u>3 Way</u>	<u>4 Way</u>
In Line		
Valve -		
Height:	1 11/16	2 3/16
Width:	5/8	5/8
Depth:	1	1
Weight:	1.5 oz.	2.5 oz.

Selection Chart

Differential Pressure Valve

A 3 or 4 way, in line air piloted valve is available for use in pressure compensating circuits. Valves can be used to maintain pressure in balancing or leveling applications.

A pilot pressure (min. 30 PSI), is applied to control port 14, operating the spool and allowing flow. When pressure is equalized on the secondary side of the valve (connected via a second pilot port - 12), the valve is closed by the return spring.

For a manifold mounted version, use valve **84212** and connect the secondary balance pressure to port 12 of the manifold or sub base section.

Description		Catalog number	
		In Line Mounted	Manifold Mounted
3 Way Single Air Pilot Spring Return		79012	---
4 Way Single Air Pilot Spring Return		81012	84212
4 Way Double Air Pilot Detent		81014	84214
3 Way Differential Pressure Valve		79016	---
4 Way Differential Pressure Valve		81016	---

Sub bases / Manifolds

Manifold kits are available for both in-line or sub base mounted valves. See *accessories for miniature solenoid valves*. Single sub bases for mounting Series 83 or 84 valves are available in 2 versions:

An aluminum sub base, catalog number **84402-01** can be used to individually mount manifold valves. Base dimensions are 2 5/8" L x 1" W x 3/8" H. Tapped holes (M4) at each corner are used for mounting the base. 10-32 (M5) porting is through the bottom.

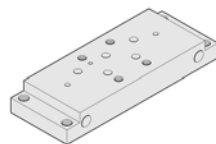

A special molded sub base cat. no. **83450** has instant push in fittings for 5/32 (4mm) tubing and fully adjustable flow controls to provide a compact valve package. Dimensions are 2 3/4" L x 1" W x 3/4" H.

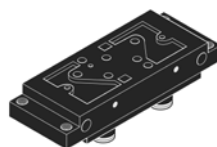

Series 83 – Manifold Mounted, 4 Way Resilient Seal Spool Valves

Single Air Pilot **83212**
Double Air Pilot, Detent **83214**

Pneumatically actuated resilient seal spool valves are also available. For technical details see solenoid operated Series 83 valves in the solenoid section of this catalog.

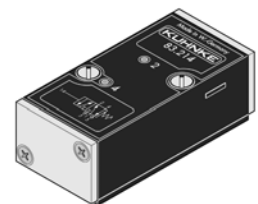

The Series 83 valve is manifold mounted, has red pop up indicators and uses standard Kuhnke 10-32 manifolds or sub bases. The body is a molded material.

Miniature Valves

Series 85, 87 Spool Valves

Kuhnke Miniature Valves

Steel Spool Valves, Pneumatically Operated (1/8 Ports)

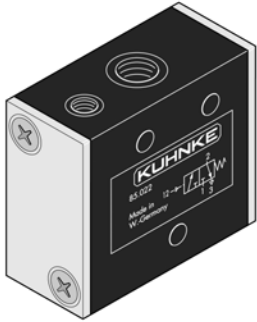

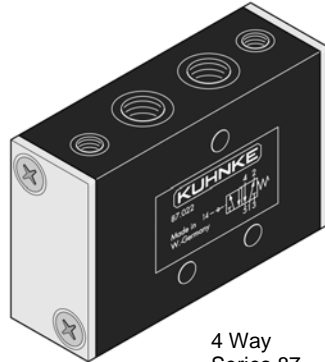

3 Way
Series 85



4 Way
Series 87

Series 85 and 87 pneumatically operated spool valves are constructed of precision lapped steel spools and sleeves.

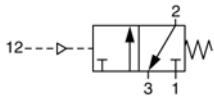
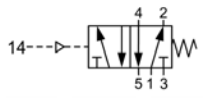
In addition to in line mounting, four way pneumatically operated valves can also be mounted on Kuhnke series 87 manifolds. See solenoid valve accessories.

Description	Catalog Number	
	NPT Ports (USA Std.)	Metric Ports (European Std.)
3 Way Single Air Pilot Spring Return 	(Not Available)	85022
4 Way Single Air Pilot Spring Return 	87122	87022
4 Way Double Air Pilot Detent 	87124	87024

Technical Specifications

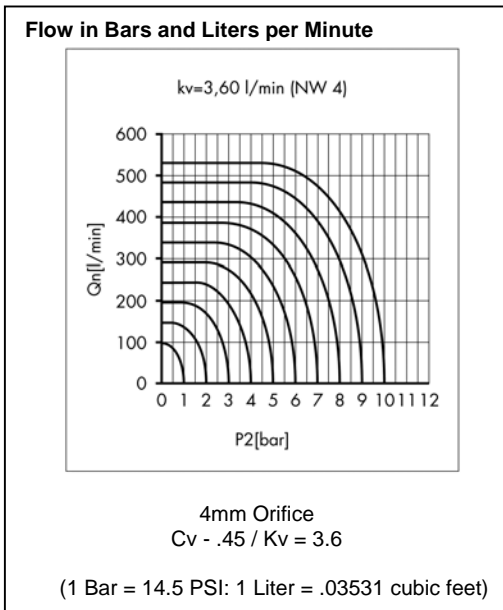

Operating Pressure:

30 to 145 PSI.

Vacuum:

Not applicable.

Flow Rate:

25 CFM @ 100 PSI

10 CFM @ 45 PSI

Cv/Kv:

Cv - 0.45

Kv - 3.6

Orifice:

4mm

Connection:

1/8 ports

Media:

Filtered Air

Materials:

Aluminum housing, hardened steel spool and sleeve, Buna N seals, plated end caps.

Average Mechanical Life:

100 million operations

Operating Ambient:

-10°C to 70°C (12°F to 160°F)

Operation:

Operated by pneumatic signal.

Dimensions (inches):

	3 Way	4 Way
Height:	1 13/16	2 7/16
Width:	3/4	3/4
Depth:	1 3/4	1 3/4
Weight:	5 oz.	6 oz.

Selection Chart

Differential Pressure Valve

A 3 or 4 way, in line air piloted valve is available for use in pressure compensating circuits. Valves can be used to maintain pressure in balancing or leveling applications.

A pilot pressure (min. 30 PSI), is applied to control port 14, operating the spool and allowing flow. When pressure is equalized on the secondary side of the valve (connected via a second pilot port - 12), the valve is closed by the return spring.

For a manifold mounted version, use valve **84212** and connect the secondary balance pressure to port 12 of the manifold or sub base section.

Description		Catalog number	
		In Line Mounted	Manifold Mounted
3 Way Single Air Pilot Spring Return		79012	---
4 Way Single Air Pilot Spring Return		81012	84212
4 Way Double Air Pilot Detent		81014	84214
3 Way Differential Pressure Valve		79016	---
4 Way Differential Pressure Valve		81016	---

Sub bases / Manifolds

Manifold kits are available for both in-line or sub base mounted valves. See *accessories for miniature solenoid valves*. Single sub bases for mounting Series 83 or 84 valves are available in 2 versions:

An aluminum sub base, catalog number **84402-01** can be used to individually mount manifold valves. Base dimensions are 2 5/8" L x 1" W x 3/8" H. Tapped holes (M4) at each corner are used for mounting the base. 10-32 (M5) porting is through the bottom.

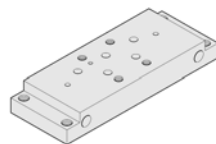

A special molded sub base cat. no. **83450** has instant push in fittings for 5/32 (4mm) tubing and fully adjustable flow controls to provide a compact valve package. Dimensions are 2 3/4" L x 1" W x 3/4" H.

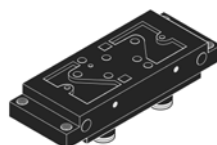

Series 83 – Manifold Mounted, 4 Way Resilient Seal Spool Valves

Single Air Pilot **83212**
Double Air Pilot, Detent **83214**

Pneumatically actuated resilient seal spool valves are also available. For technical details see solenoid operated Series 83 valves in the solenoid section of this catalog.

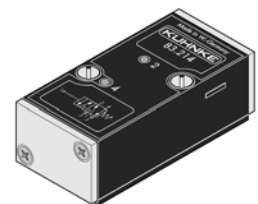

The Series 83 valve is manifold mounted, has red pop up indicators and uses standard Kuhnke 10-32 manifolds or sub bases. The body is a molded material.

Miniature Valves

Series 85, 87 Spool Valves

Kuhnke Miniature Valves

Steel Spool Valves, Pneumatically Operated (1/8 Ports)

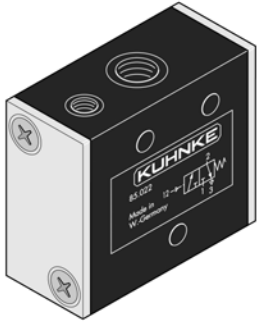

3 Way
Series 85

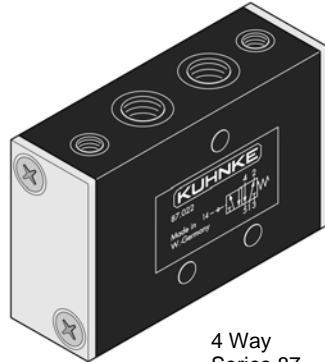

4 Way
Series 87

Series 85 and 87 pneumatically operated spool valves are constructed of precision lapped steel spools and sleeves.

In addition to in line mounting, four way pneumatically operated valves can also be mounted on Kuhnke series 87 manifolds. See solenoid valve accessories.

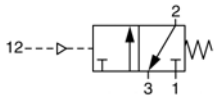
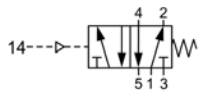
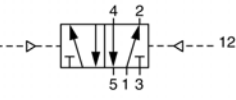
Description	Catalog Number	
	NPT Ports (USA Std.)	Metric Ports (European Std.)
3 Way Single Air Pilot Spring Return 	(Not Available)	85022
4 Way Single Air Pilot Spring Return 	87122	87022
4 Way Double Air Pilot Detent 	87124	87024

Technical Specifications

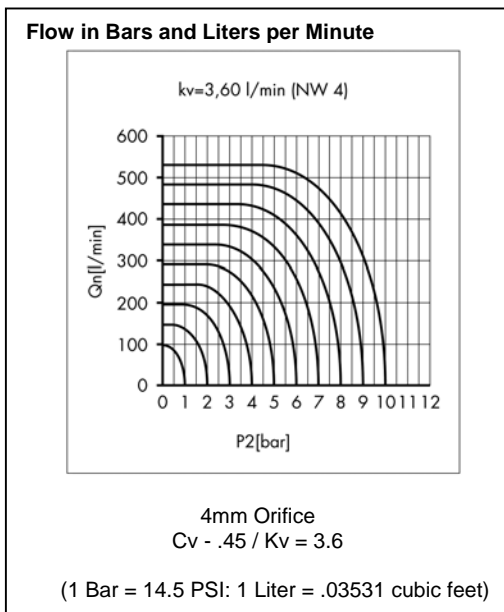

Operating Pressure:

30 to 145 PSI.

Vacuum:

Not applicable.

Flow Rate:

25 CFM @ 100 PSI

10 CFM @ 45 PSI

Cv/Kv:

Cv - 0.45

Kv - 3.6

Orifice:

4mm

Connection:

1/8 ports

Media:

Filtered Air

Materials:

Aluminum housing, hardened steel spool and sleeve, Buna N seals, plated end caps.

Average Mechanical Life:

100 million operations

Operating Ambient:

-10°C to 70°C (12°F to 160°F)

Operation:

Operated by pneumatic signal.

Dimensions (inches):

	3 Way	4 Way
Height:	1 13/16	2 7/16
Width:	3/4	3/4
Depth:	1 3/4	1 3/4
Weight:	5 oz.	6 oz.

The following page(s) are extracted from multi-page Kuhnke product catalogues or CDRoms and any page number shown is relevant to the original document. The PDF sheets here may have been combined to provide technical information about the specific product(s) you have selected.

Hard copy product catalogues, and CDRoms have been published describing Kuhnke Pneumatics, Solenoids, Relays and Electronics; some divided into different books. A list of current publications is available on this web site or from our sales offices. Some may be available for download, but as substantially larger files.

Contact Details

Kuhnke sales and service in North America

Kuhnke
Automation Inc.
P.O Box 1369
Wayne, N.J.

T: (973) 633 0690
F: (973) 633 7230
Email: sales@kuhnkeusa.com

Important Note

The information shown in these documents is for guidance only. No liability is accepted for any errors or omissions. The designer or user is solely responsible for the safe and proper application of the parts, assemblies or equipment described.

Miniature Valves

Kuhnke Miniature Valves

Accessories

(Manual and Mechanically Operated Valves)

Plunger Operated 2 Way Poppet Valve

42250

Material: Brass
Flow: 3 CFM @ 100 PSI
Dimensions: 1 3/4" L x 1/2" Hex.
Weight: 1 oz.
Mounting: Mounts in 5/16" hole

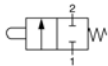

Plunger operated valve can be used to detect end of travel. Actuation force is pressure dependent and is approx. 1.1 lbs. at 90 PSI. Actuation stroke is between 1/64" and 1/16". Rear port accepts 1/8 ID tubing, secondary port is 10-32 (M5).

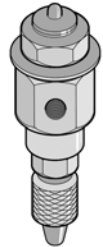

One Way Trip Mechanism

42300

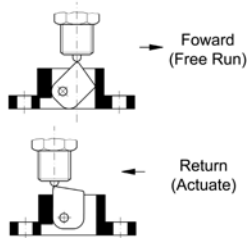

One way trip mechanism can be used with plunger or ball operated valves. In one direction, mechanism forces ball to actuate valve. In the opposite traveling direction, mechanism is forced into base offering no resistance for valve switching. Tripping mechanism travel into base is 5/64". Overall dimensions: 1 1/8" L x 1/4" W x 3/8" H.

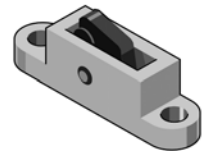

Air Bleed Hose and Nozzle

43138

Hose and nozzle accessory for Series 79, 81 and 72 air jet detector valves. Hose is 18" long, 5/32" OD tubing with push-in nozzle. A fitting is also included. Tubing can be cut to size.



Mounting Brackets

Flat Mounting Bracket **43010-1**
L Shaped Mounting Bracket **43010-2**

Dimensions:

Flat – 1" H x 1 9/16" W.
L shape – 3/4" H. x 1 9/16" W x 3/8" D.
Mounting holes (2) 1/8" Dia. on 1 1/4" Centers.

Used to mount mechanically operated valves with screw thread mounting collar and nut. Made from zinc plated sheet steel. Valve mounting hole is 1/2 inch diameter.

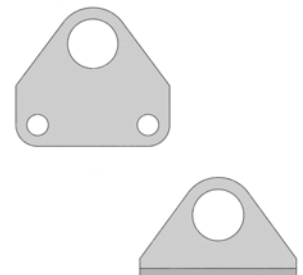

Miniature Valves

Accessories

Kuhnke Miniature Valves

(Manual and Mechanically Operated Valves)

Miniature OT Pushbutton Operators

Kuhnke series 46, 74, 79 and 81 valves can be used with *Moeller* type M22 oil tight pushbuttons. See *individual types for valve catalog numbers*. Operators are used on control panels to enable pneumatic valves to be mounted along with electromechanical devices. Operators are standard miniature size (7/8" dia. mounting hole). For selection and descriptions of pushbuttons visit www.moeller.net. To order operators, contact *Moeller* directly. Following are typical actuator catalog numbers;

Description	Moeller Type	Moeller Article No.
Momentary Pushbutton	M22-D-S	216590
Two position Selector	M22-S-WR	216856
Mushroom Head Pushbutton	M22-DP-S	216712
Latching Pushbutton	M22-PV	216876
Key Lock	M22-WRS	216887

Replacement Operators

2 Way Roller Lever	MM4930017
One Way Roller Lever	MM4930016
Cat Whisker (79/81)	MM4920003

Miniature Valves

Accessories

Kuhnke Miniature Valves

(Manual and Mechanically Operated Valves)

Miniature OT Pushbutton Operators

Kuhnke series 46, 74, 79 and 81 valves can be used with *Moeller* type M22 oil tight pushbuttons. See *individual types for valve catalog numbers*. Operators are used on control panels to enable pneumatic valves to be mounted along with electromechanical devices. Operators are standard miniature size (7/8" dia. mounting hole). For selection and descriptions of pushbuttons visit www.moeller.net. To order operators, contact *Moeller* directly. Following are typical actuator catalog numbers;

Description	Moeller Type	Moeller Article No.
Momentary Pushbutton	M22-D-S	216590
Two position Selector	M22-S-WR	216856
Mushroom Head Pushbutton	M22-DP-S	216712
Latching Pushbutton	M22-PV	216876
Key Lock	M22-WRS	216887

Replacement Operators

2 Way Roller Lever	MM4930017
One Way Roller Lever	MM4930016
Cat Whisker (79/81)	MM4920003

Appendix

The following page(s) are extracted from multi-page Kuhnke product catalogues or CDRoms and any page number shown is relevant to the original document. The PDF sheets here may have been combined to provide technical information about the specific product(s) you have selected.

Hard copy product catalogues, and CDRoms have been published describing Kuhnke Pneumatics, Solenoids, Relays and Electronics; some divided into different books. A list of current publications is available on this web site or from our sales offices. Some may be available for download, but as substantially larger files.

Contact Details

Kuhnke sales and service in North America

Kuhnke
Automation Inc.
P.O Box 1369
Wayne, N.J.

T: (973) 633 0690
F: (973) 633 7230
Email: sales@kuhnkeusa.com

Important Note

The information shown in these documents is for guidance only. No liability is accepted for any errors or omissions. The designer or user is solely responsible for the safe and proper application of the parts, assemblies or equipment described.

Inch/Millimeter Equivalent Chart

FRACTIONS			DECIMALS			MILLIMETERS			
	$\frac{1}{64}$	0.015625	—	0.397		$\frac{33}{64}$	0.515625	—	13.097
	$\frac{1}{32}$.03125	—	0.794		$\frac{17}{32}$.53125	—	13.494
	$\frac{3}{64}$.046875	—	1.191		$\frac{35}{64}$.546875	—	13.891
	$\frac{1}{16}$.0625	—	1.588		$\frac{9}{16}$.5625	—	14.288
	$\frac{5}{64}$.078125	—	1.984		$\frac{19}{32}$.578125	—	14.684
	$\frac{3}{32}$.09375	—	2.381		$\frac{37}{64}$.59375	—	15.081
$\frac{1}{8}$	$\frac{7}{64}$.109375	—	2.778		$\frac{39}{64}$.609375	—	15.478
	$\frac{9}{64}$.1250	—	3.175	$\frac{5}{8}$	$\frac{41}{64}$.625	—	15.875
	$\frac{5}{32}$.140625	—	3.572		$\frac{21}{32}$.640625	—	16.272
	$\frac{11}{64}$.15625	—	3.969		$\frac{43}{64}$.65625	—	16.669
	$\frac{3}{16}$.171875	—	4.366		$\frac{11}{16}$.671875	—	17.066
	$\frac{13}{64}$.1875	—	4.762		$\frac{23}{32}$.6875	—	17.462
	$\frac{7}{32}$.203125	—	5.159		$\frac{45}{64}$.703125	—	17.859
$\frac{1}{4}$	$\frac{15}{64}$.21875	—	5.556		$\frac{47}{64}$.71875	—	18.256
	$\frac{17}{64}$.234375	—	5.953	$\frac{3}{4}$	$\frac{49}{64}$.734375	—	18.653
	$\frac{9}{32}$.2500	—	6.350		$\frac{25}{32}$.75	—	19.050
	$\frac{19}{64}$.265625	—	6.747		$\frac{51}{64}$.765625	—	19.447
	$\frac{11}{16}$.28125	—	7.144		$\frac{13}{16}$.78125	—	19.844
	$\frac{5}{8}$.296875	—	7.541		$\frac{27}{32}$.796875	—	20.241
	$\frac{13}{32}$.3125	—	7.938		$\frac{53}{64}$.8125	—	20.638
	$\frac{7}{16}$.328125	—	8.334		$\frac{29}{32}$.828125	—	21.034
	$\frac{21}{64}$.34375	—	8.731	$\frac{7}{8}$	$\frac{55}{64}$.84375	—	21.431
$\frac{3}{8}$	$\frac{23}{64}$.359375	—	9.128		$\frac{61}{64}$.859375	—	21.828
	$\frac{25}{64}$.3750	—	9.525		$\frac{15}{16}$.875	—	22.225
	$\frac{13}{32}$.390625	—	9.922		$\frac{31}{32}$.890625	—	22.622
	$\frac{27}{64}$.40625	—	10.319		$\frac{63}{64}$.90625	—	23.019
	$\frac{7}{16}$.421875	—	10.716		$\frac{1}{2}$.921875	—	23.416
	$\frac{29}{64}$.4375	—	11.112		$\frac{1}{1}$.9375	—	23.812
	$\frac{15}{32}$.453125	—	11.509			.953125	—	24.209
	$\frac{31}{64}$.46875	—	11.906			.96875	—	24.606
	$\frac{1}{2}$.484375	—	12.303			.984375	—	25.003
		.5	—	12.700			1.000	—	25.400

1 mm = .03937" National Bureau of Standards Miscellaneous Publication 286 .001" = .0254 mm

Handy Conversion Factors

- Area**
 - 1 sq. inch = 645.16 sq. millimeters
 - 1 sq. millimeter = .00155 sq. inches
- Linear**
 - 1 inch = 25.4 mm
 - 1 mm = .03937 inches
- Flow Standard**
 - Cv = .0702 Kv (in liters per min.)
 - Kv = 14.245 Cv
- Weight**
 - 1 pound = .454 kilograms
 - 1 kilogram = 2.205 pounds
- Force**
 - 1 oz. force = .278 newton
 - 1 newton = 3.597 ozs. force
 - 1 lb. force = 4.448 newton
 - 1 newton = .2248 lbs. force
- Pressure**
 - 1 bar = 14.5 PSI
 - 1 PSI = .07 bar
- Temperature**
 - Fahrenheit = (C x 1.8)+32
 - Centigrade = (F-32) x 5/9
- Torque**
 - 1 inch oz = .07042 Ncm
 - 1 newton centimeter = 1.146 inch ozs.
 - 1 inch lb. = 11.364 Ncm
 - 1 newton centimeter = .088 inch lbs.
- Volume**
 - 1 cu. inch = .01639 liters
 - 1 cu. foot = 28.317 liters
 - 1 liter = 61.024 cu. inches
 - 1 liter = .03531 cu. feet

The following page(s) are extracted from multi-page Kuhnke product catalogues or CDRoms and any page number shown is relevant to the original document. The PDF sheets here may have been combined to provide technical information about the specific product(s) you have selected.

Hard copy product catalogues, and CDRoms have been published describing Kuhnke Pneumatics, Solenoids, Relays and Electronics; some divided into different books. A list of current publications is available on this web site or from our sales offices. Some may be available for download, but as substantially larger files.

Contact Details

Kuhnke sales and service in North America

Kuhnke
Automation Inc.
P.O Box 1369
Wayne, N.J.

T: (973) 633 0690
F: (973) 633 7230
Email: sales@kuhnkeusa.com

Important Note

The information shown in these documents is for guidance only. No liability is accepted for any errors or omissions. The designer or user is solely responsible for the safe and proper application of the parts, assemblies or equipment described.

General Hints and Reminders

Miniature Pneumatics-General

Today's industry, because of increased costs, and severe competition, is forced to find new ways of automating work tasks to maintain a competitive edge. Miniature Pneumatics provide a low cost answer for all types of automation solutions. The Kuhnke miniature pneumatic line is a broad selection of devices, from valves-to cylinders-to specialty devices that provide reliable solutions for most automation applications.

Valves

Choose a valve that provides the flow required to drive your cylinder or sub-circuit, but no need to oversize. Over sizing takes up space, and very often is more expensive. When working with miniature pneumatics, consider using flow in CFM and cylinder volume as a basis for sizing, instead of Cv value. Cv or Kv measurements have origins in heavy Hydraulic systems applications, where severe ambient conditions and fluid temperatures weigh heavily on valve sizing.

A rule of thumb worth considering-in typical applications; the valve orifice size should be about 10% of the diameter of the cylinder bore your operating.

Cylinders

Avoid side loads on piston rods; always mount cylinders on the centerline of workloads. For optimum cylinder life, use external stops whenever possible in your design. External stops take away the shock on cylinder piston and seals at the end of rod travel. Avoid running cylinders at higher pressures than actually needed.

Special Components/Logic Devices

Many miniature pneumatic components are very much like fine instruments and should be treated as such. Devices such as timers and pressure switches have fine regulators and or air motors where clean air is essential. If your designing a pneumatic circuit, try to isolate the smaller pilot devices from the main system working devices with a separate line filter, an extra precaution, but particularly useful in dirty environments or with poor preventive maintenance practice.

Fittings

Always keep a supply of fittings on hand. A supply of extra fittings saves time and money. Fittings are always the last thing to worry about (if not forgotten) when assembling a pneumatic system.

Assembling fittings to pneumatic devices can be an easy job, especially on miniature pneumatic devices. 10-32 (M5) and 1/8" fittings practically tighten themselves, and therefore caution should be used when tightening fittings with a wrench. Always use a short wrench to avoid applying high torque to fittings. Kuhnke fittings are supplied with sealing washers or O-Rings, so the use of sealant is not required. If desired, use a small amount of sealant on the male threads close to the top of the fitting, but avoid using a Teflon tape sealant, since small pieces of tape tend to break off as the fitting is tightened. These loose pieces can find their way into valve or other device mechanisms obstructing the free flow of air.

Try to use swivel or banjo type fittings whenever possible. Although more expensive, swivel fittings allow removal of fittings without disassembling tubing connections, making servicing or modifications easy.

If you use barb fittings with plastic hose, cut tubing straight and stick it in hot water for a minute, before installing it, it'll make assembly much easier.

Air Quality-Lubrication-Filtering

Compressed air quality for all pneumatic systems is essential to provide long life of components as well as to insure proper functioning of machinery at all times. When setting up a pneumatic system, consider adequate filtering, drying and lubrication devices.

Filters with 5-micron filtration capabilities are recommended. Regular cleaning or replacement of filters is recommended. Drying of air, particularly in humid or low temperature areas should be considered. Preventing condensation within the pneumatic operating system reduces chances of corrosion of components, prolonging life. Drying is essential when operating systems at the ambient temperatures close to freezing. Generally when ambient or compressed air temperatures are at 4°C (38°F), the dew point of air must be held at least 10°C (Approx. 15°F) lower than the lowest occurring temperature.

All Kuhnke components are lubricated at the factory. Therefore components can be used in lubricated or unlubricated systems. After using components in a lubricated system, do not switch to an unlubricated system. After a short period of time, the oils used in lubricated systems wash away factory grease lubrication. Switching to a dry system will then cause the components to "run dry:" increasing wear.

For lubrication, Shell Tellus Oil-C10 or equivalent should be used. Avoid over lubricating.

Safety

Compressed air and other fluids under pressure, by their nature, are dangerous, and should be treated with caution. Always observe local and National Safety Standards. Standards set by OSHA and organizations such as the Fluid Power Association provide standards and a basis for practical applications of pneumatic devices. Contact these organizations for more information.

Some basic rules to follow:

1. Don't allow the operating pressure of the system to be higher than it was designed for.
2. Design a system so that no dangerous actions or processes will occur upon a failure of system air pressure.
3. Controls should be arranged so that unwanted, inadvertent, accidental triggering of movement is prevented.
4. Control lines (air and electrical) should be placed out of the way and protected to avoid damage.
5. In automatic systems the sequencing of operations should be set up in such a way as to prevent super imposing or crossing over of processes.
6. Exhausts should be arranged so that moments of danger from escaping air are avoided (i.e. Injury to eyes from whirling chips.)
7. Cylinder and rotary actuators (working elements) should be mounted and protected according to OSHA standards.

Servicing

Set up a regular preventive maintenance schedule. Some things to consider:

1. Check air quality. Be sure air filters are cleaned or replaced regularly. If a lubrication system is used check that the correct amount of oil is being supplied. Don't let lubricators run dry. Avoid over lubricating.
2. Check wear and tear regularly. Check piston rods, mountings and rod nuts for tightness. Check shock absorbers if used. Look for worn brackets, fixtures etc.
3. Check electrical connections.
4. Check fittings.

About This Catalog

General:

The information in this catalog is primarily intended for selection of components by design and development engineers. The product information is the latest available at the time of printing, and is subject to constant updating, hence performance characteristics may change. We therefore cannot guarantee performance in a particular application.

Products:

Kuhnke pneumatic products are a complete line of high quality industrial grade devices with applications in packaging, sorting, weaving, printing and medical machinery and equipment. Compact size, with modular design, Kuhnke components provide unique application solutions.

How to Order:

To simplify ordering and to assure speedy delivery, order by catalog number and include a description for each item.

Stock Items:

Most of the catalog items are available from stock at Kuhnke Automation or your local distributor. Check your nearest representative for specific items. For non-stock items, delivery is normally 3 to 4 weeks.

Prices and Discounts:

For prices and discounts, consult your nearest representative or authorized Kuhnke Automation distributor for information.

Engineering Assistance:

Kuhnke maintains a competent, experienced group of design, application and sales engineers, who will assist in the selection and application of cataloged items, as well as non standard or specialized controls to meet your specific requirements.

Standard Sales Policy:

Kuhnke Automation Inc.'s Conditions of Sale for control products apply to all products. For copies of Conditions of Sale, contact your nearest authorized distributor or representative.

Application Notes:

Warning: Compressed air and other fluids, under pressure, by their nature, are dangerous and should be treated with caution. Follow OSHA and National Fluid Power Association standards and recommendations for safe operation. Employ good preventive maintenance procedures; maintain air quality and proper air pressures.

Consult factory before using any devices designed for purely pneumatic applications on liquids, or aggressive mediums.

Warranty

KUHNKE AUTOMATION INC. WARRANTS THAT THE PRODUCT SHALL BE FREE OF DEFECTS IN WORKMANSHIP AND MATERIAL FOR A PERIOD OF SIXTY DAYS FROM THE DATE OF SHIPMENT TO PURCHASER.

Should any failure to conform with this warranty appear within such time, the company shall, if given prompt notice by purchaser, correct such nonconformity at its option, either by repair or replacement F.O.B. repair facility, or by refund of the purchase price of the nonconforming product or part. Return of products to the company pursuant to this paragraph shall be at purchaser's risk and expense.

THE FOREGOING WARRANTY IS EXCLUSIVE AND IN LIEU OF ALL OTHER WARRANTIES OF QUALITY, WRITTEN, ORAL OR IMPLIED, AND ALL OTHER WARRANTIES INCLUDING ANY WARRANTY OF MERCHANTABILITY OR FITNESS FOR A PARTICULAR PURPOSE ARE HEREBY DISCLAIMED.

Correction of nonconformities in the manner and for the period of time provided above shall be purchaser's exclusive remedy and shall constitute fulfillment of all liabilities of **KUHNKE AUTOMATION INC.**, whether in warranty, strict liability, contract, negligence, tort or otherwise with respect to any nonconformance or defect in the product.

The foregoing warranty shall not apply to any product which has been a) improperly repaired or altered, b) subjected to misuse, misapplication, negligence or accident, or c) used in a manner contrary to manufacturer's directions.

LIMITATION OF LIABILITY

IN NO EVENT SHALL KUHNKE AUTOMATION INC. BE LIABLE FOR SPECIAL, INDIRECT, INCIDENTAL, OR CONSEQUENTIAL DAMAGES, whether in warranty, contract, strict liability, tort, negligence, or otherwise, including but not limited to loss of profits or revenue, loss of use of the product or any associated product, cost of capital, cost of substitute products, facilities or services, downtime costs, or claims of customers of the purchaser for such or other damages.

Kuhnke Automation Inc.'s liability to purchaser on any claim in connection with the product shall not exceed the purchase price of the product which gives rise to the claim.

Except as prohibited by law, all causes of action against Kuhnke Automation Inc. shall expire unless brought within one year of the time of accrual thereof.

KUHNKE AUTOMATION INC. NEITHER ASSUMES NOR AUTHORIZES ANYONE TO ASSUME FOR IT ANY OTHER OR FURTHER LIABILITY THAN AS SET OUT ABOVE.

Miniature Valve Catalog Number Listing

Cat. No.	Page	Cat. No.	Page	Cat. No.	Page
42250	53	68201-00	18	83244-xx	30
42300	53	68230-01	18	83450	30
43010-1	53	68240-xx	17	84212	51
43010-2	53	71-750-026-01-00	33,35	84214	51
43138	53	72010 to 72030	41	84215	49
44404-xx	35	74000 to 74010	43	84221	33
46000 to 46010	45	76036-01-00	31	84230-xx	27
50812	34,35	76036-02-00	31	84234-xx	27
50813	35	76136-01-00	31	84236	49
50814	35	76136-02-00	31	84240-xx	27
560.100.040.020	23	76410-00-xx	31	84244-xx	27
560-110-110-015	34,35	76410-02-xx	31	84402-01	27
63020 to 63055	9	76420-03-01	31	84463	33
63071 to 63079	11	76420-03-03	31	84465	33
63086 to 63089	12	79012	51	85022	52
63091-41	13	79016	51	85030-xx	29
63095	14	79017-03	48	85040-xx	29
63100-xx	14	79020 to 79023	47	86406-xx	13
63110 to 63131	7	79024 to 79026	49	87022	52
63230-02	14	79027 to 79029	48	87024	52
64001 to 64077	21	79030-xx	27	87030-xx	29
64130	32	79036	49	87037-xx	29
64157-xx	37	79040-xx	27	87040-xx	29
64230-01	37	81012	51	87044-xx	29
64255-xx	32	81014	51	87122	52
64390-xx	14	81016	51	87124	52
65111 to 65271	21	81017-03	48	87140-xx	29
65280-xx	32	81020 to 81023	47	87144-xx	29
65370	32	81024 to 81026	49	87350-xx	34
65412	23	81027 to 81029	48	87351	34
65495-xx	37	81030-xx	27	87355-xx	35
65553-xx	38	81034-xx	27	87360-xx	34
67100 to 67161	25	81040-xx	27	87452-xx	35
67200-xx	32	81044-xx	27	JL49000xx	36
67224	32	81110-xx	33	JL59100xx	36
67230-xx	38	81111	33	MM4920003	54
67499-xx	37	83212	51	MM4930016	54
67500	32	83214	51	MM4930017	54
68030 to 68050	17	83230-xx	30	MPP91130-36-00	14
68110-xx	18	83234-xx	30	MPP91130-39-00	14
68135	18	83240-xx	30		

Miniature Valves

Air Bleed Nozzle Valve	41,49	Miniature Solenoid Valves	19
Air Jet Detector Valve	41,49	Modular Poppet Valves	42
Amplifier Valve	49	Mounting Bases	13,27,30
Antenna Valves	48	Oil Tight Pushbutton Valve	43,45,48
Ball Operated, Air Pilot Assist Valve	48	One Way Roller Lever Valve	43,45,47
Ball Operated Valve	45	One Way Trip Mechanism	53
Bases, Valves	13,27,30	Pilot Valves	31
Brass Poppet Valves	44	Plugs, Electric	14,18,37
Cat Whisker	48	Plunger Air Pilot Assist	41,48
Coils	36	Plunger Operated Valve	43,45,47
Common Input Manifold	35	Pneumatically Operated Valves	45,50,52
Connectors, Electrical	14,18,37	Pressure Balancing Valve	51
Control Valves (manual)	39	Pulse Shaper Valve	49
Differential Pressure Valves	51	Pushbutton Valves	43,45,47
Direct Mounted Solenoid Valves	21,23	Resilient Seal Spool Valve	30,51
Directional Control Valves	26	Roller Lever Air Pilot Assisted Valve	41
Electrical Connectors	14,18,37	Roller Lever Body Mount Valve	43,45,47
Electrically Operated Valves (Micro)	5	Sockets, Electric	14,18,37
Electrically Operated Valves (Miniature)	19	Solenoid 3 Way	5,19
Four Way Valves	26,46	Solenoid Coils	36
Impulse Valve	49	Solenoid Operated Valves	5,19
In Line Mounted Valves	19	Specifications	56
Joystick	43	Spool Valves	26,46
LED Indicators	38	Step Up Valve (Amplifier)	49
Limit Switch Valves	41,43,45,47	Sub Bases	13,27,30
Luminous Seal	38	Surge Suppressors	38
Manifolds	10,13,17,32	Technical Information	56
Manually Operated Valves	39	Toggle Switch Valve	43,45
Mechanically Operated Micro Valves	40	Whisker Valve	48
Mechanically Operated Valves	39	Wobble Stick Valve	43
Micro Solenoid Valves	5		